

# Amplifier Transistors

## NPN Silicon

**2N5088**  
**2N5089**

### MAXIMUM RATINGS

Rating	Symbol	2N5088	2N5089	Unit
Collector–Emitter Voltage	$V_{CEO}$	30	25	Vdc
Collector–Base Voltage	$V_{CBO}$	35	30	Vdc
Emitter–Base Voltage	$V_{EBO}$	3.0		Vdc
Collector Current — Continuous	$I_C$	50		mAdc
Total Device Dissipation @ $T_A = 25^\circ\text{C}$ Derate above $25^\circ\text{C}$	$P_D$	625	5.0	mW mW/°C
Total Device Dissipation @ $T_C = 25^\circ\text{C}$ Derate above $25^\circ\text{C}$	$P_D$	1.5	12	Watts mW/°C
Operating and Storage Junction Temperature Range	$T_J, T_{stg}$	–55 to +150		°C

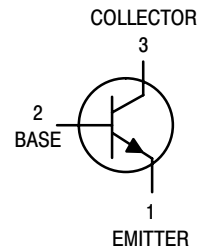
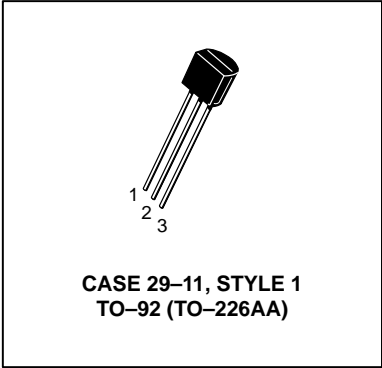

### THERMAL CHARACTERISTICS

Characteristic	Symbol	Max	Unit
Thermal Resistance, Junction to Ambient	$R_{\theta JA}^{(1)}$	200	°C/W
Thermal Resistance, Junction to Case	$R_{\theta JC}$	83.3	°C/W

### ELECTRICAL CHARACTERISTICS ( $T_A = 25^\circ\text{C}$ unless otherwise noted)

Characteristic	Symbol	Min	Max	Unit
----------------	--------	-----	-----	------

### OFF CHARACTERISTICS

Collector–Emitter Breakdown Voltage <sup>(2)</sup> ( $I_C = 1.0 \text{ mAdc}, I_B = 0$ )	$V_{(BR)CEO}$	30 25	— —	Vdc
Collector–Base Breakdown Voltage ( $I_C = 100 \mu\text{Adc}, I_E = 0$ )	$V_{(BR)CBO}$	35 30	— —	Vdc
Collector Cutoff Current ( $V_{CB} = 20 \text{ Vdc}, I_E = 0$ ) ( $V_{CB} = 15 \text{ Vdc}, I_E = 0$ )	$I_{CBO}$	— —	50 50	nAdc
Emitter Cutoff Current ( $V_{EB(\text{off})} = 3.0 \text{ Vdc}, I_C = 0$ ) ( $V_{EB(\text{off})} = 4.5 \text{ Vdc}, I_C = 0$ )	$I_{EBO}$	— —	50 100	nAdc

- $R_{\theta JA}$  is measured with the device soldered into a typical printed circuit board.
- Pulse Test: Pulse Width  $\leq 300 \mu\text{s}$ , Duty Cycle  $\leq 2.0\%$ .

## 2N5088 2N5089

### ELECTRICAL CHARACTERISTICS ( $T_A = 25^\circ\text{C}$ unless otherwise noted) (Continued)

Characteristic	Symbol	Min	Max	Unit
<b>ON CHARACTERISTICS</b>				
DC Current Gain ( $I_C = 100\ \mu\text{Adc}$ , $V_{CE} = 5.0\ \text{Vdc}$ )	$h_{FE}$	300	900	—
	2N5088	400	1200	
	2N5089			
( $I_C = 1.0\ \text{mAdc}$ , $V_{CE} = 5.0\ \text{Vdc}$ )		350	—	
	2N5088	450	—	
	2N5089			
( $I_C = 10\ \text{mAdc}$ , $V_{CE} = 5.0\ \text{Vdc}$ )(2)		300	—	
	2N5088	400	—	
	2N5089			
Collector–Emitter Saturation Voltage ( $I_C = 10\ \text{mAdc}$ , $I_B = 1.0\ \text{mAdc}$ )	$V_{CE(sat)}$	—	0.5	Vdc
Base–Emitter On Voltage ( $I_C = 10\ \text{mAdc}$ , $V_{CE} = 5.0\ \text{Vdc}$ )(2)	$V_{BE(on)}$	—	0.8	Vdc
<b>SMALL–SIGNAL CHARACTERISTICS</b>				
Current–Gain — Bandwidth Product ( $I_C = 500\ \mu\text{Adc}$ , $V_{CE} = 5.0\ \text{Vdc}$ , $f = 20\ \text{MHz}$ )	$f_T$	50	—	MHz
Collector–Base Capacitance ( $V_{CB} = 5.0\ \text{Vdc}$ , $I_E = 0$ , $f = 1.0\ \text{MHz}$ )	$C_{cb}$	—	4.0	pF
Emitter–Base Capacitance ( $V_{EB} = 0.5\ \text{Vdc}$ , $I_C = 0$ , $f = 1.0\ \text{MHz}$ )	$C_{eb}$	—	10	pF
Small–Signal Current Gain ( $I_C = 1.0\ \text{mAdc}$ , $V_{CE} = 5.0\ \text{Vdc}$ , $f = 1.0\ \text{kHz}$ )	$h_{fe}$	350	1400	—
	2N5088	450	1800	
	2N5089			
Noise Figure ( $I_C = 100\ \mu\text{Adc}$ , $V_{CE} = 5.0\ \text{Vdc}$ , $R_S = 1.0\ \text{k}\Omega$ , $f = 1.0\ \text{kHz}$ )	NF	—	3.0	dB
	2N5088	—	2.0	
	2N5089			

2. Pulse Test: Pulse Width  $\leq 300\ \mu\text{s}$ , Duty Cycle  $\leq 2.0\%$ .

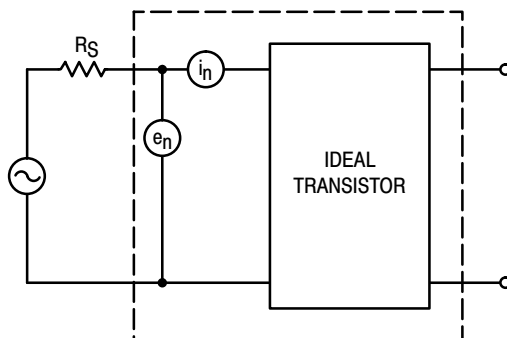

**Figure 1. Transistor Noise Model**

**NOISE CHARACTERISTICS**

( $V_{CE} = 5.0 \text{ Vdc}$ ,  $T_A = 25^\circ\text{C}$ )

**NOISE VOLTAGE**

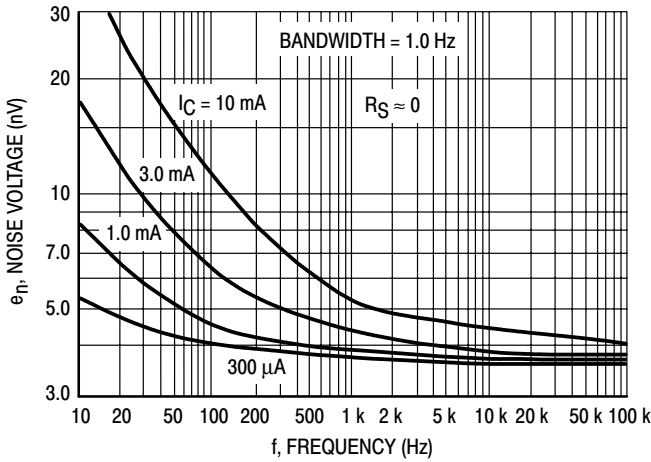

Figure 2. Effects of Frequency

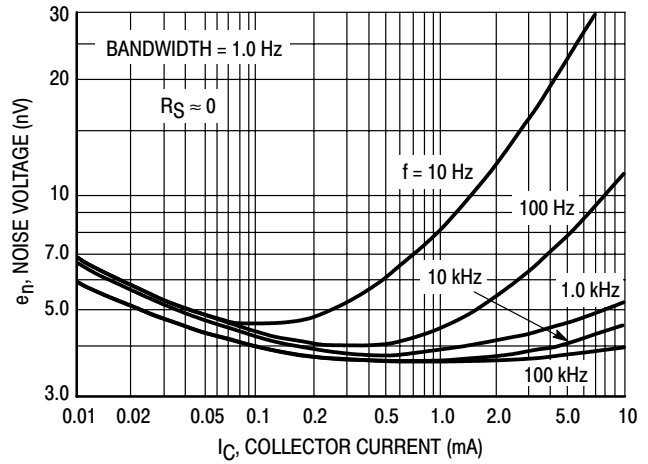

Figure 3. Effects of Collector Current

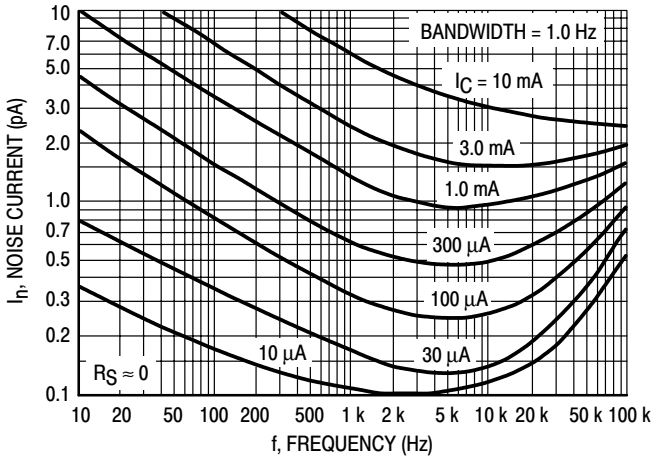

Figure 4. Noise Current

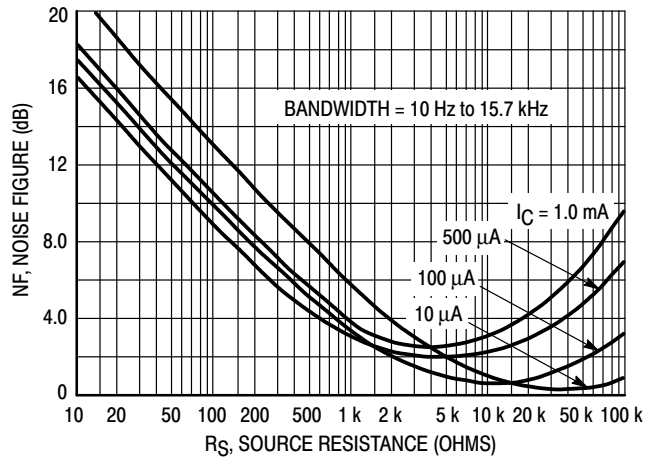

Figure 5. Wideband Noise Figure

**100 Hz NOISE DATA**

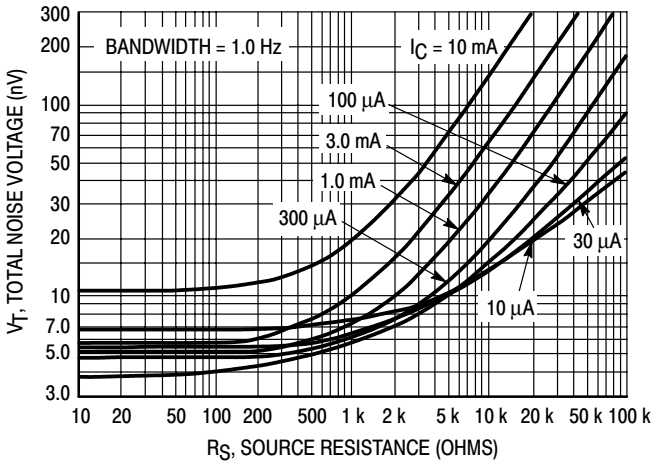

Figure 6. Total Noise Voltage

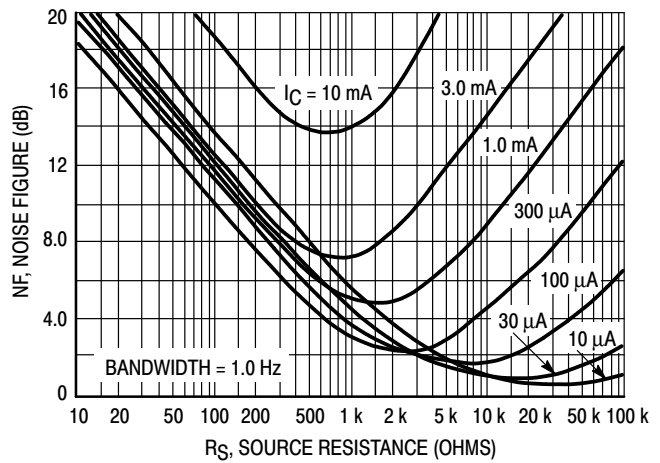

Figure 7. Noise Figure

# 2N5088 2N5089

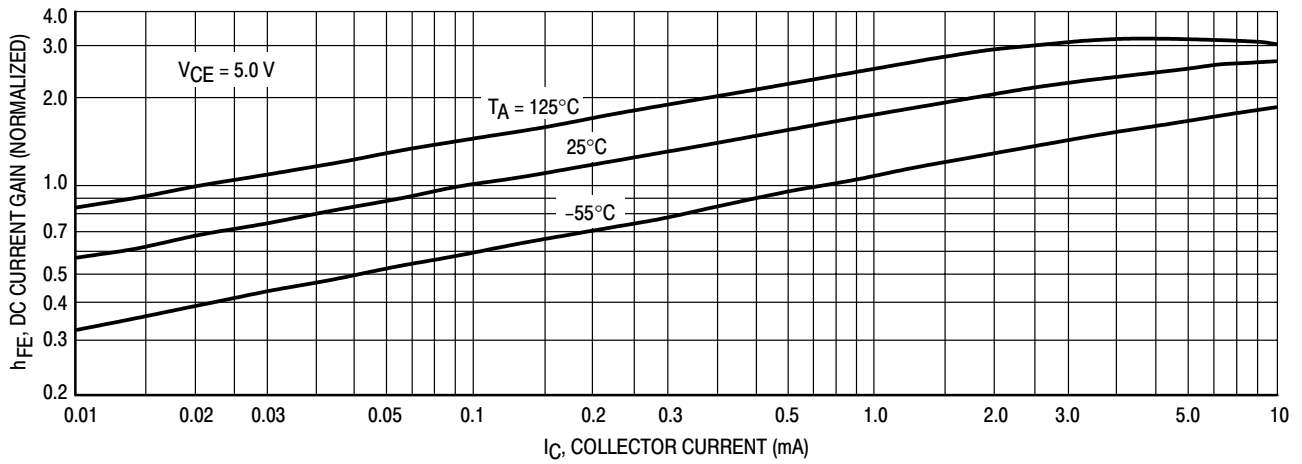

Figure 8. DC Current Gain

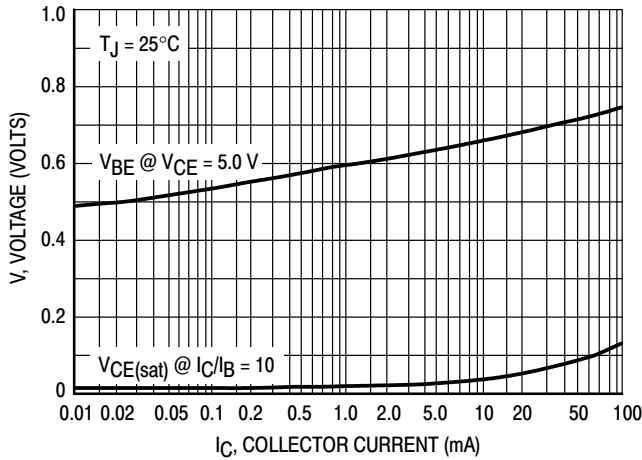

Figure 9. "On" Voltages

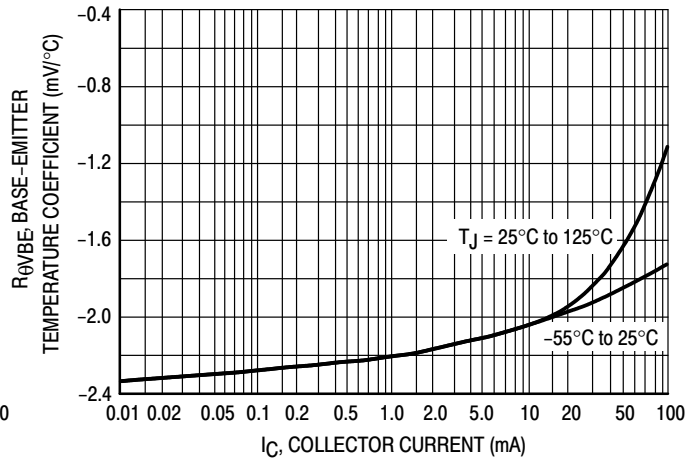

Figure 10. Temperature Coefficients

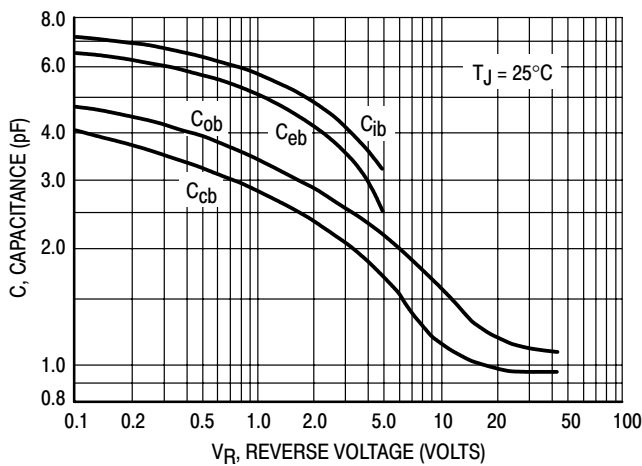

Figure 11. Capacitance

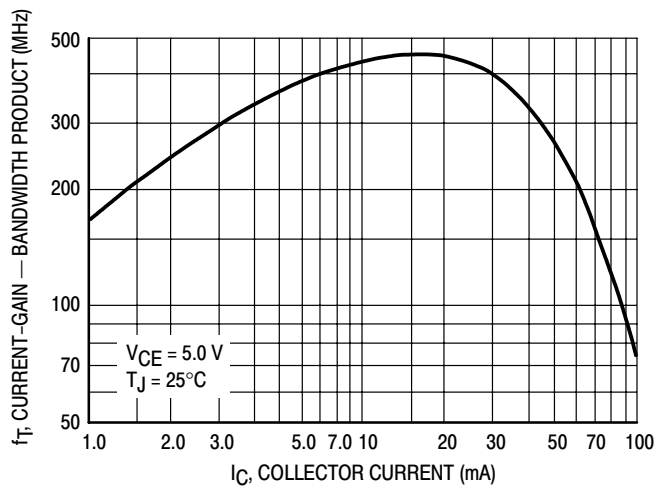
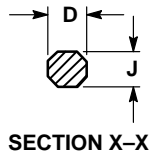
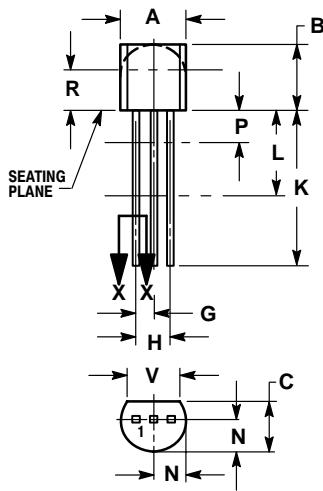

Figure 12. Current-Gain — Bandwidth Product

# 2N5088 2N5089

## PACKAGE DIMENSIONS

### TO-92 (TO-226) CASE 29-11 ISSUE AL



STYLE 1:  
 PIN 1. EMITTER  
 2. BASE  
 3. COLLECTOR

#### NOTES:

1. DIMENSIONING AND TOLERANCING PER ANSI Y14.5M, 1982.
2. CONTROLLING DIMENSION: INCH.
3. CONTOUR OF PACKAGE BEYOND DIMENSION R IS UNCONTROLLED.
4. LEAD DIMENSION IS UNCONTROLLED IN P AND BEYOND DIMENSION K MINIMUM.

DIM	INCHES		MILLIMETERS	
	MIN	MAX	MIN	MAX
A	0.175	0.205	4.45	5.20
B	0.170	0.210	4.32	5.33
C	0.125	0.165	3.18	4.19
D	0.016	0.021	0.407	0.533
G	0.045	0.055	1.15	1.39
H	0.095	0.105	2.42	2.66
J	0.015	0.020	0.39	0.50
K	0.500	---	12.70	---
L	0.250	---	6.35	---
N	0.080	0.105	2.04	2.66
P	---	0.100	---	2.54
R	0.115	---	2.93	---
V	0.135	---	3.43	---

## Notes

**Notes**

**ON Semiconductor** and  are trademarks of Semiconductor Components Industries, LLC (SCILLC). SCILLC reserves the right to make changes without further notice to any products herein. SCILLC makes no warranty, representation or guarantee regarding the suitability of its products for any particular purpose, nor does SCILLC assume any liability arising out of the application or use of any product or circuit, and specifically disclaims any and all liability, including without limitation special, consequential or incidental damages. "Typical" parameters which may be provided in SCILLC data sheets and/or specifications can and do vary in different applications and actual performance may vary over time. All operating parameters, including "Typicals" must be validated for each customer application by customer's technical experts. SCILLC does not convey any license under its patent rights nor the rights of others. SCILLC products are not designed, intended, or authorized for use as components in systems intended for surgical implant into the body, or other applications intended to support or sustain life, or for any other application in which the failure of the SCILLC product could create a situation where personal injury or death may occur. Should Buyer purchase or use SCILLC products for any such unintended or unauthorized application, Buyer shall indemnify and hold SCILLC and its officers, employees, subsidiaries, affiliates, and distributors harmless against all claims, costs, damages, and expenses, and reasonable attorney fees arising out of, directly or indirectly, any claim of personal injury or death associated with such unintended or unauthorized use, even if such claim alleges that SCILLC was negligent regarding the design or manufacture of the part. SCILLC is an Equal Opportunity/Affirmative Action Employer.

## PUBLICATION ORDERING INFORMATION

### Literature Fulfillment:

Literature Distribution Center for ON Semiconductor  
P.O. Box 5163, Denver, Colorado 80217 USA  
**Phone:** 303-675-2175 or 800-344-3860 Toll Free USA/Canada  
**Fax:** 303-675-2176 or 800-344-3867 Toll Free USA/Canada  
**Email:** ONlit@hibbertco.com

**N. American Technical Support:** 800-282-9855 Toll Free USA/Canada

**JAPAN:** ON Semiconductor, Japan Customer Focus Center  
4-32-1 Nishi-Gotanda, Shinagawa-ku, Tokyo, Japan 141-0031  
**Phone:** 81-3-5740-2700  
**Email:** r14525@onsemi.com

**ON Semiconductor Website:** <http://onsemi.com>

For additional information, please contact your local Sales Representative.