

# C&K NE-18 Series Mains / Power Switches



## Features/Benefits

- Chassis or panel mount
- Various buttons
- Various contact configurations
- RoHS compliant

## Typical Applications

- Mains/power switching
- Consumer electronics
- Audio equipment
- Digital products

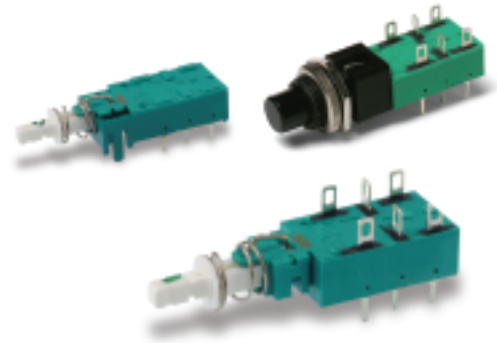

## Specifications

### POWER CONTACT:

SWITCHING POWER MAX. AC/DC: NE18: 1500/100 W,  
NE18CTII: 1000/100 W; AC (Inductive  $\cos \phi = 0.6$ ): NE18: 900W,  
NE18CTII: 600W.

SWITCHING VOLTAGE MAX. AC/DC: 250/100V

### SWITCHING CURRENT MAX. AC/DC

AC (Inductive  $\cos \phi = 0.6$ ): NE18:  $6 A^2$ /1 A, NE18CTII:  $4 A^2$ /1 A

INRUSH CURRENT MAX. AC<sup>1</sup>): NE18: 36 A, NE18CTII: 64 A

DIELECTRIC STRENGTH (50 Hz, 1 min.): 2000 V

OPERATING LIFE AT MAX. LOAD AND AT MAX. INRUSH  
CURRENT:  $\sim 10^4$  operations<sup>5</sup>)

CONTACT RESISTANCE: Initial: 50m $\Omega$ ; After  $10^4$  operations: 70m $\Omega$ .

INSULATION RESISTANCE:  $\sim 10^{12}$   $\Omega$ chassis – nearest contact;  
 $\sim 10^{12}$   $\Omega$ mains contact – mains contact;  $\sim 10^{12}$   $\Omega$ mains contact –  
mains contact after  $10^4$  operations.

### LOW VOLTAGE CONTACT:

SWITCHING POWER MAX.: 12W

SWITCHING VOLTAGE MAX.: 24V

SWITCHING CURRENT MAX.: 0.5A

TOTAL TRAVEL: 4.7mm (.185 inch)

LATCHING TRAVEL: 3.3mm (.130 inch)

OPERATING FORCE: Without auxiliary low voltage contacts:

NE18: 7N (700 grams); NE18CTII: 9.5N (950 grams).

With auxiliary low voltage contacts: NE18: 8N (800 grams);

NE18CTII: 11N (1100 grams).

SEALING: Dust proof.

## Materials

HOUSING, ACTUATOR & TERMINAL BOARD: Thermoplastic polyester (UL 94V-0).

MOVABLE CONTACT: Silver nickel alloy, silver plated.

FIXED CONTACTS: Silver nickel alloy, silver plated.

COMMON CONTACTS & TERMINALS: Copper alloy, silver plated.

RETURN SPRING: Music wire.

**NOTE:** For the latest information regarding RoHS compliance, please go to:  
[www.ittcannon.com/rohs](http://www.ittcannon.com/rohs). All models are RoHS compliant and compatible.

**NOTE:** Specifications and materials listed above are for switches with standard options.  
For information on specific and custom switches, consult Customer Service Center.

## Build-A-Switch

To order, simply select desired option from each category and place in the appropriate box. Available options are shown and described on pages A-100 thru A-106. For additional options not shown in catalog, consult Customer Service Center.

If requesting only a switch, select the switch as noted below. Buttons are sold separately.

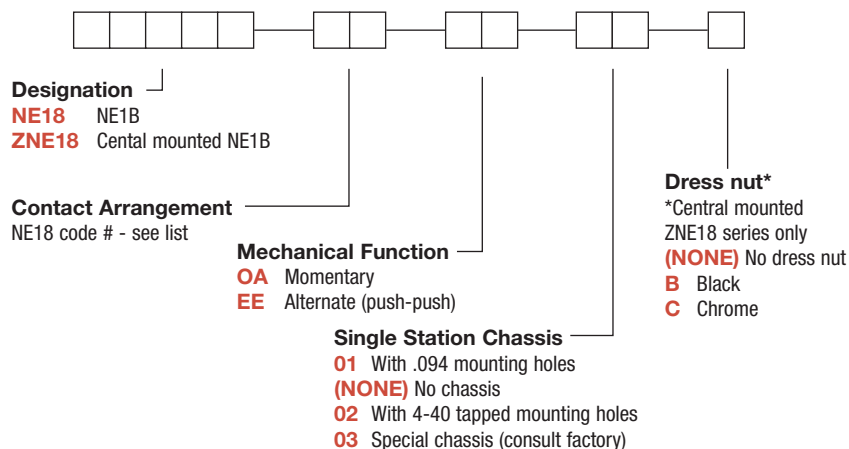

Dimensions are shown: Inches (mm)  
Specifications and dimensions subject to change



# C&K NE-18 Series Mains / Power Switches

A

Pushbutton

## Order Code - Buttons

### Solid Buttons

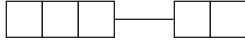

#### Style

- F01** FMR
- F02** FG\*
- F12** FSC
- F13** FSD
- F14** FU12
- F15** FSB
- F16** FE
- F19** FA
- F21** F001

#### Button Color

- 01** Black
- 02** White
- 03** Red
- 04** Light gray

### Mechanical Indicator Buttons

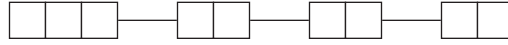

#### Style

- F01** FA100
- F02** FA101
- F07** FA120
- F08** FA201
- F11** FA200\*

#### Shell Color

- 01** Black

#### Out Position Color

- 01** Black

#### In Position Color

- 02** White
- 06** Yellow
- 07** Blue
- 08** Green
- 12** Orange

\*Button options for central mounting configurations, use 'FG' for central mount with chrome dress nut, use 'FA200' for central mount with black dress nut.

## BUTTON REMOVAL

A button of a push-push switch should only be removed in the "OFF" non-latching position.

## DESIGNATION & SWITCHES WITH STANDARD OPTIONS



### NE1838EE

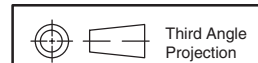
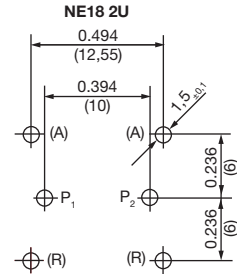
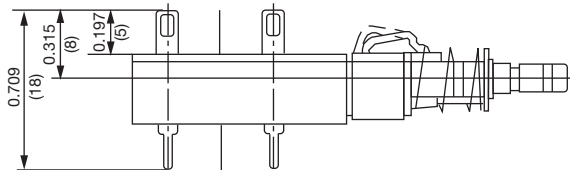
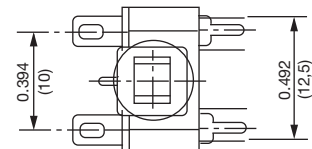
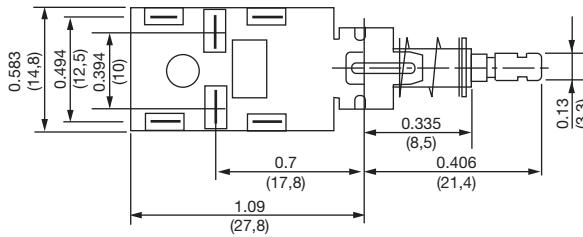
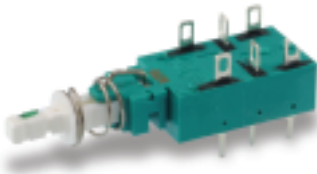

Dimensions are shown: Inches (mm)  
Specifications and dimensions subject to change

# C&K NE-18 Series Mains / Power Switches



A

Pushbutton

## DESIGNATION & SWITCHES WITH STANDARD OPTIONS



### NE1839EE

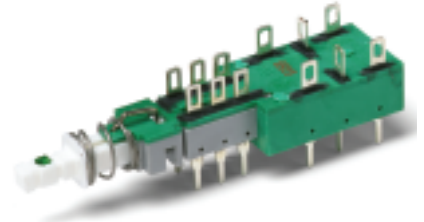
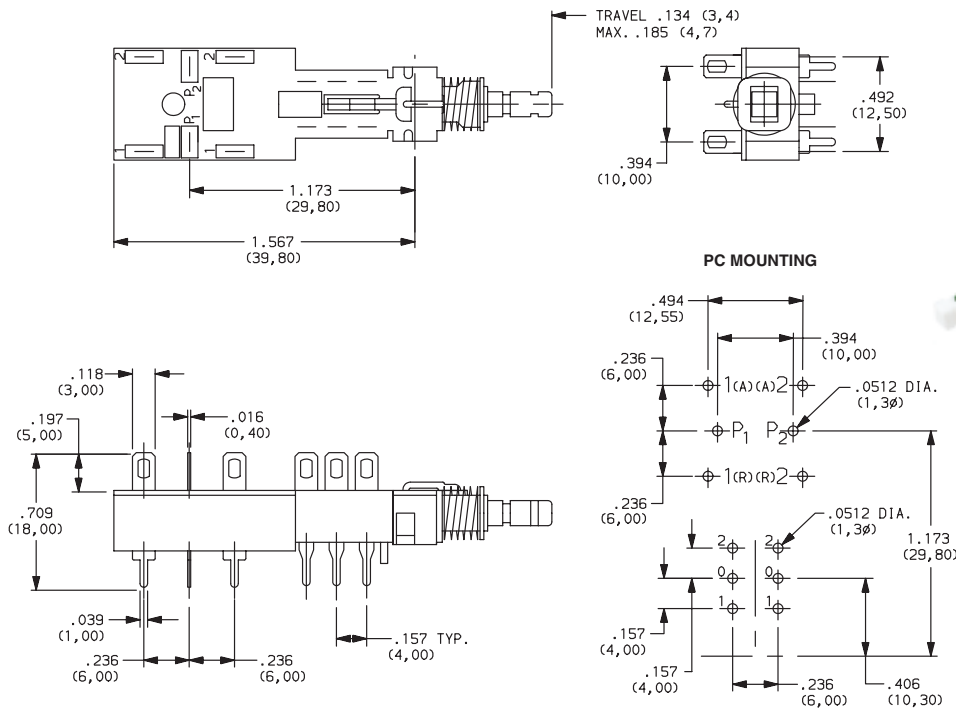

### NE1848EE

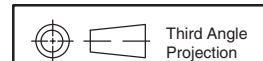
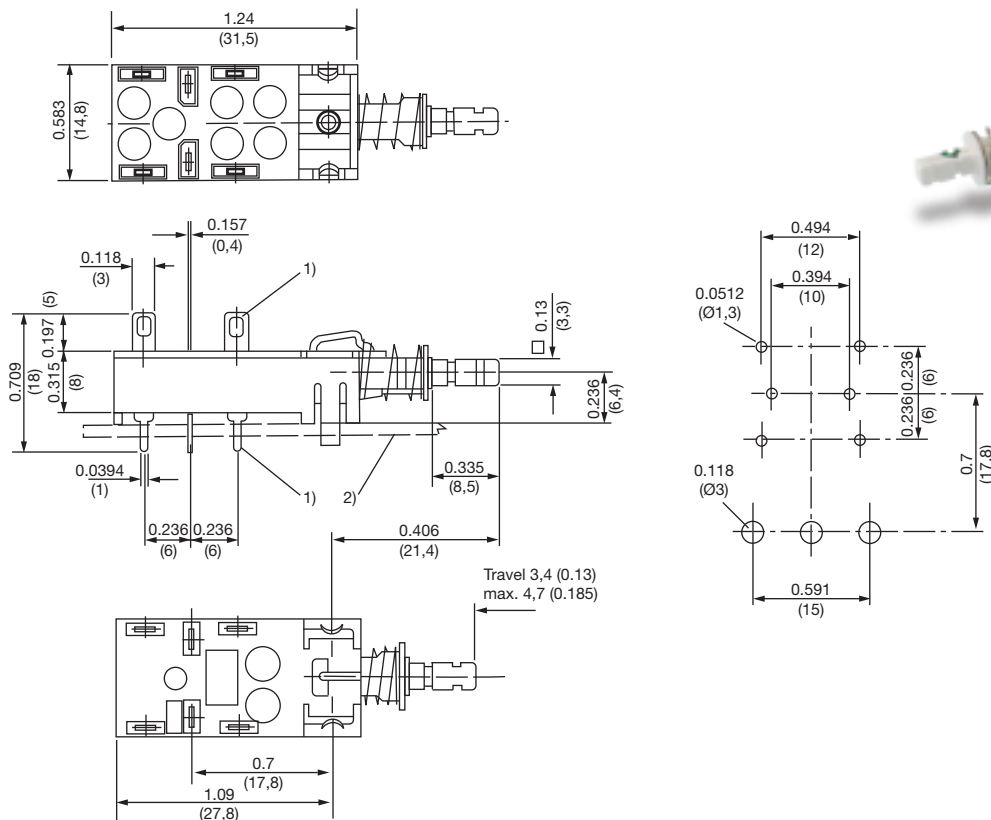

Dimensions are shown: Inches (mm)  
Specifications and dimensions subject to change



A

Pushbutton

# DESIGNATION & SWITCHES WITH STANDARD OPTIONS



## ZNE1838EECF0201

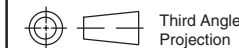
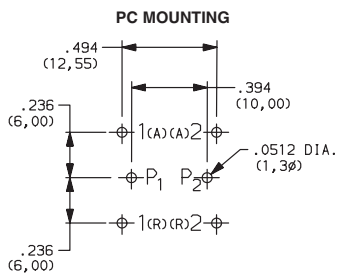
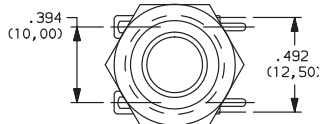
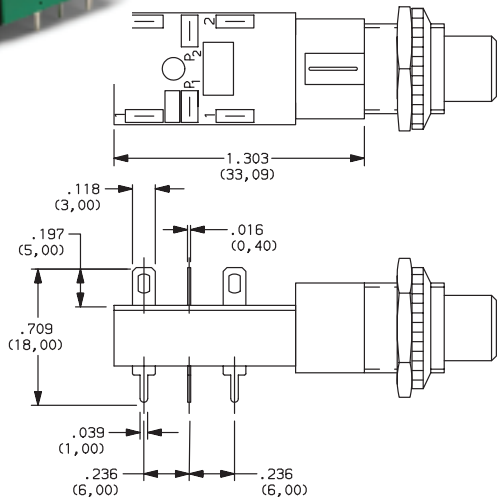

Dimensions are shown: Inches (mm)  
Specifications and dimensions subject to change

# C&K NE-18 Series Mains / Power Switches



## CONTACT ARRANGEMENT



OPTION CODE Contact capacity and availability	STYLE	ELECTRICAL CIRCUIT
<b>37</b>	NE18 – 2AX	DPST
<b>38</b>	NE18 – 2UX	DPDT
<b>51</b>	2U + NE18 – 2AX	DPST*
<b>52 (4A/64)</b>	NE18CTII – 2AX	DPST
<b>39</b>	2U + NE18 – 2UX	DPDT*
<b>41</b>	NE18 – 2AP	DPST
<b>42</b>	NE18 – 2UP	DPDT
<b>43</b>	NE18 – 2AW	DPST
<b>44</b>	NE18 – 2UW	DPDT
<b>45</b>	NE18 – 2ASX	DPST

OPTION CODE Contact capacity and availability	STYLE	ELECTRICAL CIRCUIT
<b>46</b>	NE18 – 2USX	DPDT
<b>47</b>	NE18 – 2ASP	DPST
<b>48</b>	NE18 – 2USP	DPDT
<b>49</b>	NE18 – 2ASW	DPST
<b>50</b>	NE18 – 2USW	DPDT
<b>53 (4A/64)</b>	2U + NE18CTII – 2AX	DPST
<b>54</b>	2U + NE18 – 2AW	DPST
<b>55</b>	2U + NE18 – 2AP	DPST
<b>56</b>	2U + NE18 – 2UW	DPDT
<b>57</b>	2U + NE18 – 2UP	DPDT

\* 2U + Denotes auxiliary set of low current contacts DPDT  
 2A = DPST  
 2U = DPDT  
 S = Snap-in mounting  
 X = Solder lug/PC pins  
 W = Solder lugs only  
 P = PC pins only

NOTES  
 1. Contact plating is silver on all Power Switches.  
 2. The electrical function is Break Before Make (BBM) on all Power Switches.  
 3. The terminals will be epoxy sealed.

TYPE	POSSIBLE CONTACT ARRANGEMENT		CONTACT SPACING	PROTECTION CLASS (CEE 24)	APPROVALS
	POWER CONTACTS <sup>1</sup>	AUXILIARY CONTACTS			
NE18	2A <sup>2</sup>	2U	> 3mm (.118 inch)	II	VDE, BSI, DEMKO, NEMKO, SEMKO, SEV, CSA, UL
NE18	2A <sup>2</sup> 2U	2U	> 3mm (m) (.118 inch)	I	VDE, MEEI, BSI <sup>3</sup> , DEMKO, NEMKO, SEMKO, SEV, CSA, UL
NE18CTII	2A <sup>2</sup>	2U	> 3mm (.118 inch)	II	VDE, BSI, DEMKO, CSA, SEMKO, SEV, UL, NEMKO

1) A = make contact, R = break contact, U = changeover contact, m = VDE sign for switches with a contact spacing (air gap) < 3mm (.118 inch) according to VDE 0630/CEE 24.  
 2) With 2A mains contacts: Mounting only by PC pins is not sufficient.  
 3) BSI only for 2U mains contacts.

## MECHANICAL FUNCTION



OPTION CODE	FUNCTION
<b>OA</b>	Momentary
<b>EE</b>	Alternate (push-push)

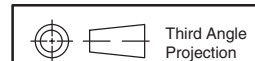

Dimensions are shown: Inches (mm)  
 Specifications and dimensions subject to change



A

Pushbutton

# C&K NE-18 Series Mains / Power Switches

## SINGLE STATION CHASSIS



01 WITH .094 MOUNTING HOLES

(NONE) NO CHASSIS

02 WITH 4-40 TAPPED MOUNTING HOLES

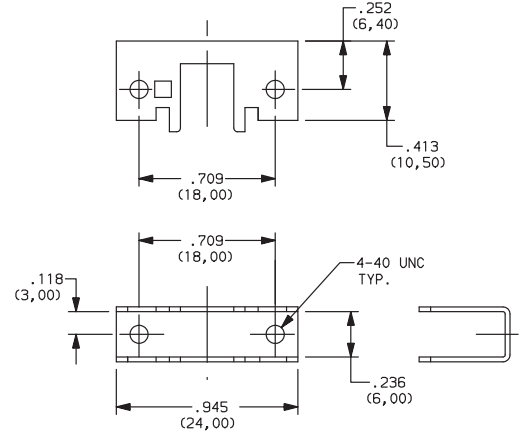
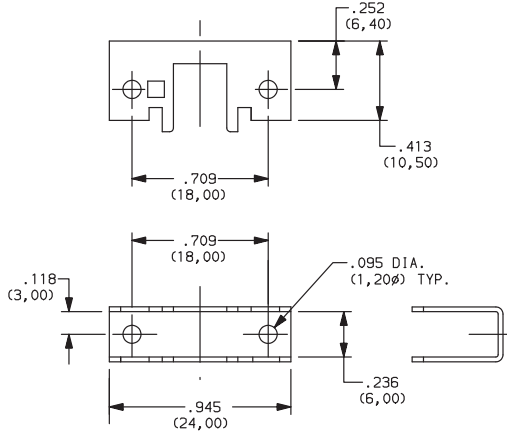

03 SPECIAL CHASSIS (CONSULT FACTORY)

## DRESS NUT



(NONE) NO DRESS NUT

B BLACK

C CHROME

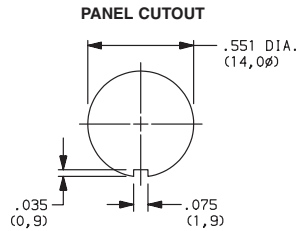
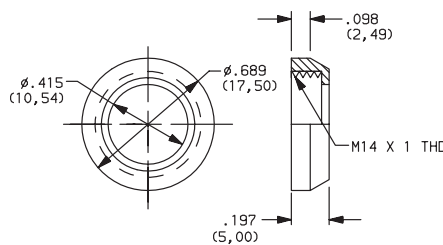

NOTE: Available with ZNE18 designation and FA200 buttons.

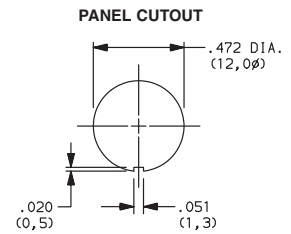
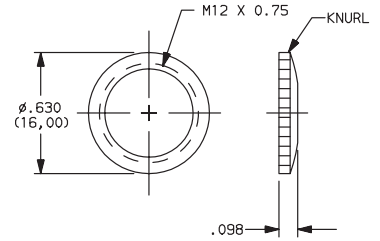

NOTE: Available with ZNE18 designation and FG button.

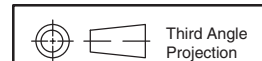

Dimensions are shown: Inches (mm)  
Specifications and dimensions subject to change

# C&K NE-18 Series Mains / Power Switches



A

Pushbutton

## SOLID BUTTON

### STYLE

**F01** FMR

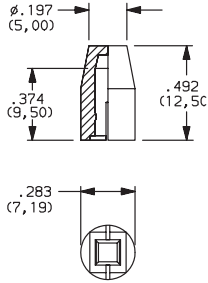

**F02** FG

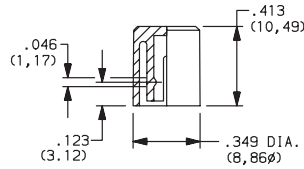

**F12** FSC

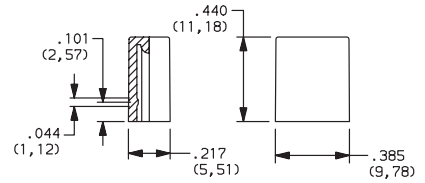
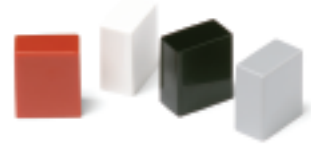

**F13** FSD

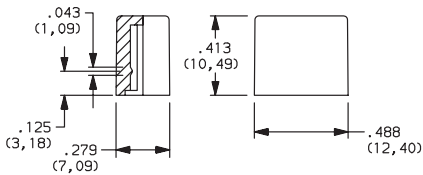
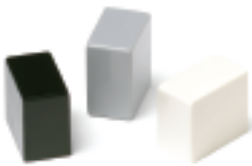

**F14** FU12

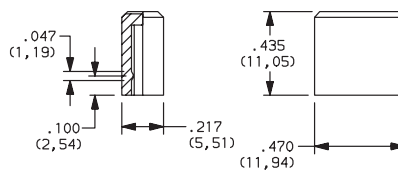
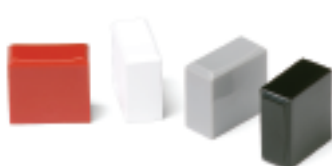

**F15** FSB

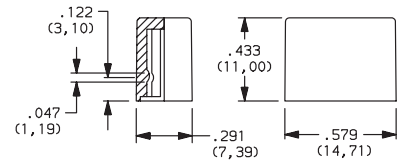
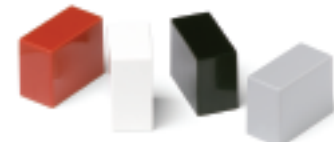

**F16** FE

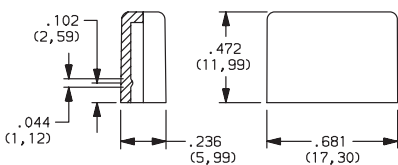
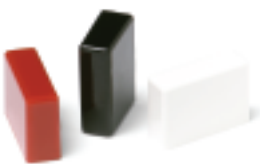

**F19** FA

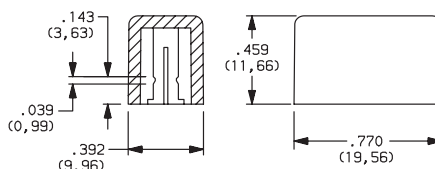

OPTION CODE	COLOR
01	BLACK
02	WHITE
03	RED
04	LT. GRAY



Third Angle Projection  
Dimensions are shown: Inches (mm)  
Specifications and dimensions subject to change



# C&K NE-18 Series Mains / Power Switches



A

Pushbutton

## SOLID BUTTON

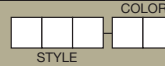

### STYLE

**F21** F001

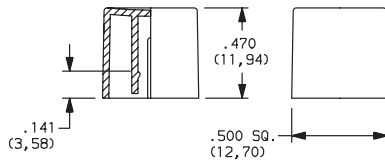

OPTION CODE	COLOR
<b>01</b>	BLACK
<b>02</b>	WHITE
<b>03</b>	RED
<b>04</b>	LT. GRAY
<b>09</b>	BLACK/CHROME (F03, F06 & F07 buttons only)

## MECHANICAL BUTTON

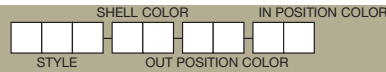

### STYLE

**F01** FA100

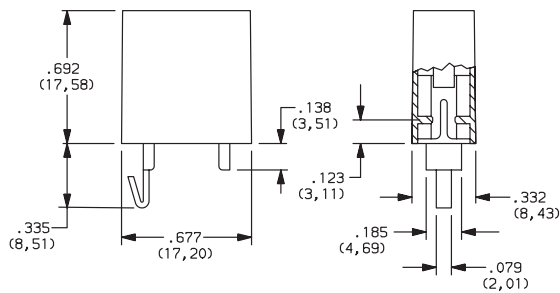

**F02** FA101

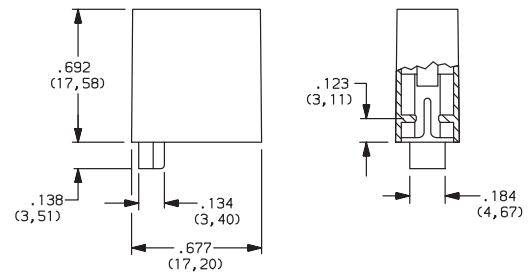

Dimensions are shown: Inches (mm)  
Specifications and dimensions subject to change





# C&K NE-18 Series Mains / Power Switches

## MECHANICAL BUTTON

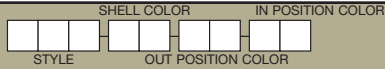

A

Pushbutton

### STYLE

**F08** FA201

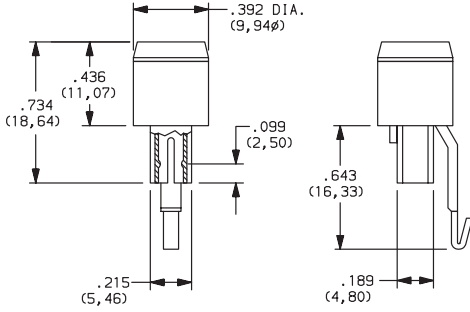

**F11** FA200

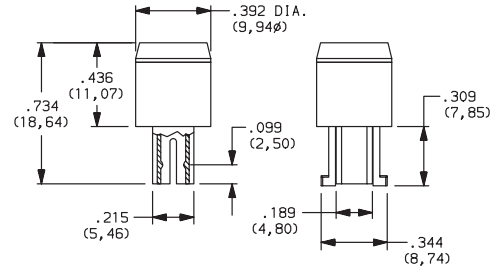

### SHELL COLOR

**01** BLACK

### OUT POSITION COLOR

**01** BLACK

### IN POSITION COLOR

OPTION CODE	COLOR
<b>02</b>	WHITE
<b>06</b>	YELLOW
<b>07</b>	BLUE
<b>08</b>	GREEN
<b>12</b>	ORANGE

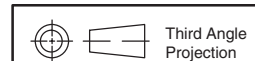

Dimensions are shown: Inches (mm)  
Specifications and dimensions subject to change