



SPECIFICATIONS

CONTACT RATING: Dependent upon contact material See page 11.

MECHANICAL LIFE: 40,000 make-and-break cycles.

CONTACT RESISTANCE: 10mΩ max. initial @ 2-4VDC
100mA for both silver and gold plated contacts.

INSULATION RESISTANCE: 1,000 MΩ min.

DIELECTRIC STRENGTH: 1,000 Vrms min. @ sea level.

OPERATING TEMPERATURE: -40°C to 85°C.

MATERIALS

CASE: Diallyl phthalate (DAP) (UL94v-0).

ACTUATOR: Brass, chrome plated.

BUSHING: Brass, nickel plated.

HOUSING: Stainless steel.

SWITCH SUPPORT: Brass, tin plated.

CONTACT / TERMINALS: Copper alloy, Silver or gold plated.

(See Page 11)



HOW TO ORDER

MODEL NO.	ACTUATOR	BUSHING	TERMINATIONS	TERMINAL PLATING	SEAL	RoHS SOLDERING
Model NO.	Actuator		Terminations	Terminal plating	Seal	RoHS soldering
1MS1 SP ON-NONE-ON	T1 10.41 high		M1 Solder lug	Q Silver	E EPOXY (std)	S RoHS & Lead Free
1MS2 SP ON-NONE-(ON)	T2 5.08 high		M2 PC thru-hole	R Gold	N NO EPOXY	
1MS3 SP ON-OFF-ON	T3 13.97 high		M3 Quick connect	C Gold over silver		
1MS4 SP (ON)-OFF-(ON)	T4 16.26 high		M51 18.70 high, wire wrap			
1MS5 SP ON-OFF-(ON)	T5 21.34 high		M52 24.20 high, wire wrap			
1MD1 DP ON-NONE-ON	T6 Flatted,anti-rotation		M53 10.55 high, wire wrap			
1MD2 DP ON-NONE-(ON)	T61 Flatted,anti-rotation		M54 26.97 high, wire wrap			
1MD3 DP ON-OFF-ON	T62 Lever handle with cap		M6 Right angle, PC thru-hole			
1MD4 DP (ON)-OFF-(ON)	T63 Flatted,anti-rotation		M6N Right angle, Snap-in, PC thru-hole			
1MD5 DP ON-OFF-(ON)	T66 13.49 high		M7 Vertical right angle, PC thru-hole			
1MD6 DP ON-ON-ON	T7 12.37 high, 15/32 bushing		VS2 11.68 high, V-bracket			
1MD7 DP (ON)-ON-(ON)	T8 17.56 high, 15/32 bushing		V2N 11.68 high, Snap-in. V-bracket			
1MD8 DP ON-ON-(ON)	T88 17.5 high, 15/32 bushing		VS3 16.00 high, V-bracket			
1M31 3P ON-NONE-ON	T9 Plastic, 21.3 high		VS4 11.68 high, V-bracket			
1M32 3P ON-NONE-(ON)	TL1 Locking lever 16.00 high		VS5 16.00 high, V-bracket			
1M33 3P ON-OFF-ON	TL2 Locking lever 16.26 high		Bushing			
1M34 3P (ON)-OFF-(ON)	TL3 Locking lever 17.28 high		B1 8.89 high, keyway (thd std)			
1M35 3P ON-OFF-(ON)			B2 8.89 high, keyway (non-thd)			
1M41 4P ON-NONE-ON			B3 7.10 high, keyway (thd)			
1M42 4P ON-NONE-(ON)			B4 7.10 high, keyway (non-thd)			
1M43 4P ON-OFF-ON			B5 7.52 high, flat (torque)			
1M44 4P (ON)-OFF-(ON)			B6 8.00 high, keyway (torque)			
1M45 4P ON-OFF-(ON)			B7 8.89 high, flat (thd std)			
1M46 4P ON-ON-ON			B8 8.89 high, keyway (metric thd)			
1M47 4P (ON)-ON-(ON)			B9 7.52 high, flat (splash proof)			
1M48 4P ON-ON-(ON)			B11 7.55 high, keyway (thd std)			
			B12 7.55 high, keyway (non-thd)			
			B13 11.38 high, keyway (15/32 bushing)			
			B14 11.90 high, flat (splash proof)			
			B15 7.55 high, flat (thd std)			
			B16 7.55 high, flat (non-thd)			
			B17 3.50 high, keyway			
			B18 11.38 high, keyway (15/32 bushing)			
			B20 11.38 high, keyway (15/32 bushing)			
			B25 8.00 high, keyway, locking lever (thd)			
			B26 8.00 high, keyway, locking lever (non-thd)			
			B52 11.70 high, flat (15/32 bushing)			



1M Series

Miniature Toggle Switches

SWITCH FUNCTION

NO. POLES	UL/CSA MODEL NO.	MODEL NO.	SWITCH FUNCTION			CONNECTED TERMINALS / SCHEMATIC		
			POS.1	POS.2	POS.3	POS.1	POS.2	POS.3
SP	Q1111	1MS1	ON	NONE	ON		N/A	
	Q1112	1MS2	ON	NONE	(ON)	2-3		2-1
	Q1113	1MS3	ON	OFF	ON			
	Q1114	1MS4	(ON)	OFF	(ON)		OPEN	
	Q1115	1MS5	ON	OFF	(ON)			
DP	Q1121	1MD1	ON	NONE	ON		N/A	
	Q1122	1MD2	ON	NONE	(ON)	2-3,5-6		2-1,5-4
	Q1123	1MD3	ON	OFF	ON			
	Q1124	1MD4	(ON)	OFF	(ON)		OPEN	
	Q1125	1MD5	ON	OFF	(ON)			
	Q1126	1MD6	ON	ON	ON			
	▲ Q1127	1MD7	(ON)	ON	(ON)	2-3,5-6	2-3,5-4	2-1,5-4
	▲ Q1128	1MD8	ON	ON	(ON)			
3P	Q1131	1M31	ON	NONE	ON		N/A	
	Q1132	1M32	ON	NONE	(ON)	2-3,5-6,8-9		2-1,5-4,8-7
	Q1133	1M33	ON	OFF	ON			
	Q1134	1M34	(ON)	OFF	(ON)		OPEN	
	Q1135	1M35	ON	OFF	(ON)			
4P	Q1141	1M41	ON	NONE	ON		N/A	
	Q1142	1M42	ON	NONE	(ON)	2-3,5-6,8-9,11-12		2-1,5-4,8-7,11-10
	Q1143	1M43	ON	OFF	ON			
	Q1144	1M44	(ON)	OFF	(ON)		OPEN	
	Q1145	1M45	ON	OFF	(ON)			
	Q1146	1M46	ON	ON	ON			
	▲ Q1147	1M47	(ON)	ON	(ON)	2-3,5-6,8-9,11-12	2-3,5-4,8-9,11-10	2-1,5-4,8-7,11-10
	▲ Q1148	1M48	ON	ON	(ON)			

() = MOMENTARY

▲ Please check the availability in advance before order

1M Toggle Switches

POLE OPTIONS

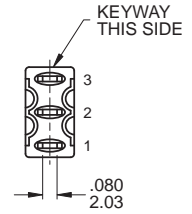
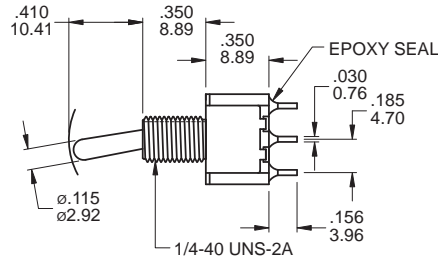
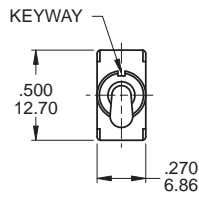

SPDT

Part No. Shown : 1MS1T1B1M1QES

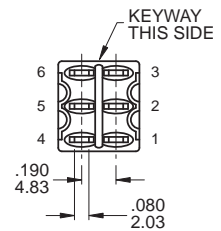
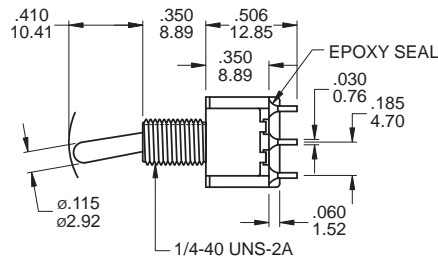
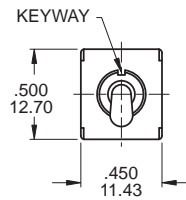

DPDT

Part No. Shown : 1MD1T1B1M1QES

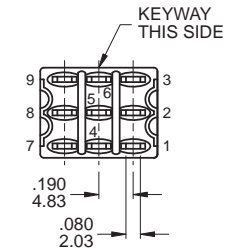
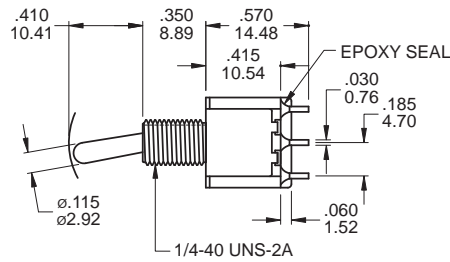
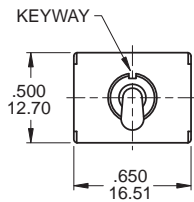

3PDT

Part No. Shown : 1M31T1B1M1QES

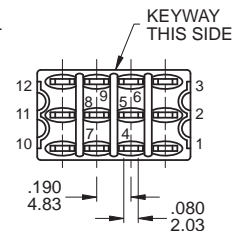
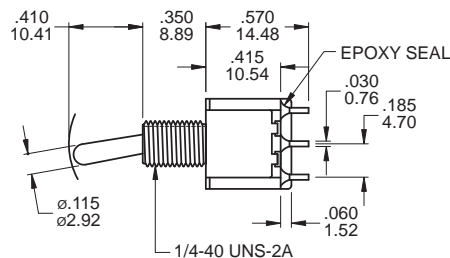
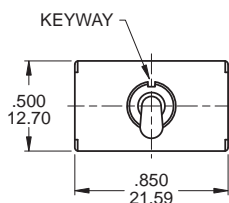

4PDT

Part No. Shown : 1M41T1B1M1QES



1M
Toggle Switches

1M Series

Miniature Toggle Switches

3-WAY SWITCH

3-Way Wiring Diagram Schematics

1M Toggle Switches

SINGLE POLE, 3 POSITION

Model No.	POS 1	POS 2	POS 3
1MD6	ON	ON	ON
Term. Comm.	2-3,5-6	2-3,5-4	2-1,5-4

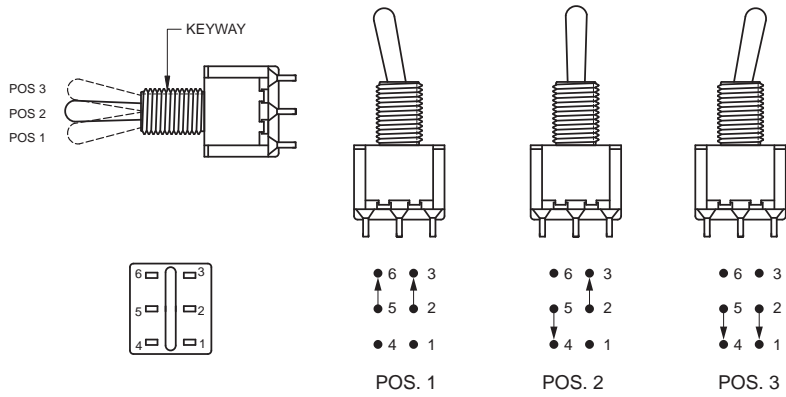

DOUBLE POLE, 3 POSITION

Model No.	POS 1	POS 2	POS 3
1M46	ON	ON	ON
Term. Comm.	2-3,5-6 8-9,11-12	2-3,5-4 8-9,11-10	2-1,5-4 8-7,11-10

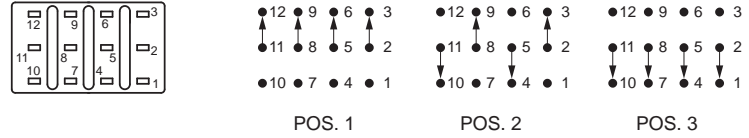

ACTUATOR OPTIONS

T1 STD

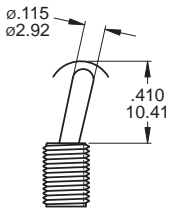

T2

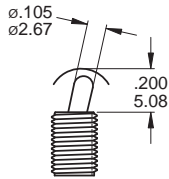

T3

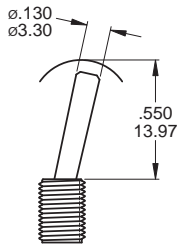

T4

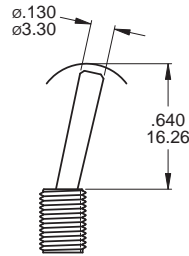

T5

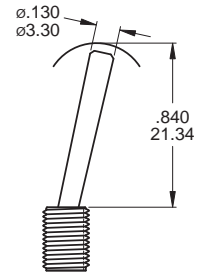

NOTE : T1 ~ T5 Actuator shown with standard B1 Bushing ;

Add .070 (1.78) for B3 Bushing ;

Subtract .020 (0.51) for B6 Bushing ;

Std for M1 , M2 Terminal sub .016 (0.40) for M6 , M7 , VSX (Exclude B1/B2 bushing)

T88B52

SPLASH PROOF

Std SPDT for M1.M2 Terminal

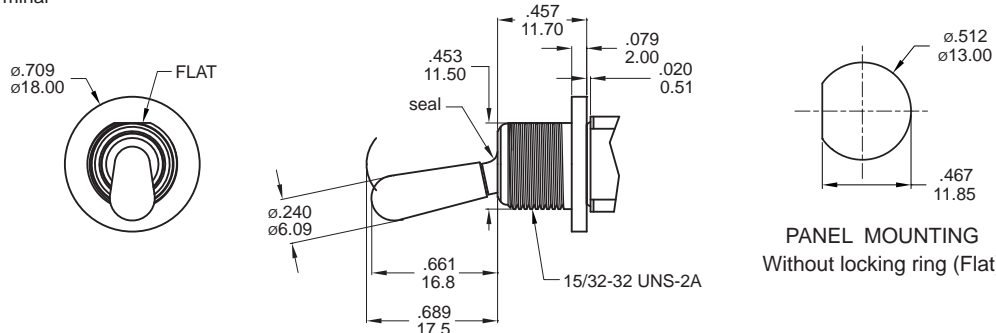

PANEL MOUNTING
Without locking ring (Flat)

T6 FLATTED WITH ANTIROTATION

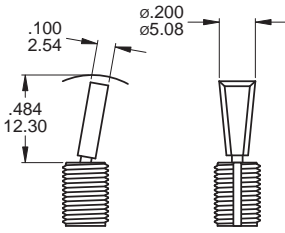

T61

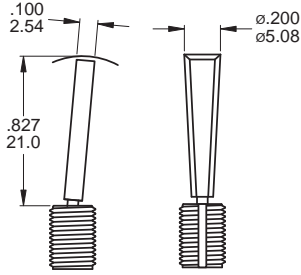

T63

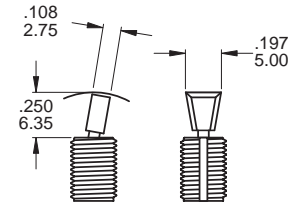

T62

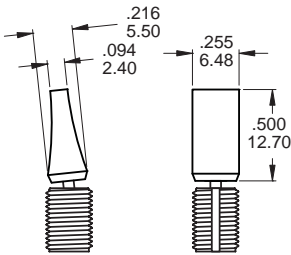

Plastic No.Color :

ITEM NO	COLOR
1	White
2	Black (Std)
3	Red
4	Orange
5	Yellow
6	Green
7	Blue
8	Brown
9	Gray

NOTE: T6,T61,T62 ,T63 use with B11, B12, B15, B16 bushing only.

* Besides standard color, other colors need to check stocks available.

T7

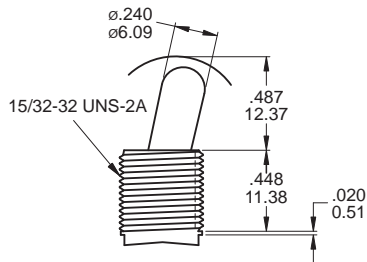

Use with B13 bushing
Use with B18,B20 the lever is antirotation and the size of lever is 13.00mm

T8

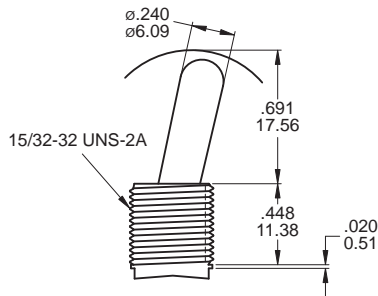

Use with B13 bushing
Use with B18,B20 the lever is antirotation and the size of lever is 18.00mm

T9

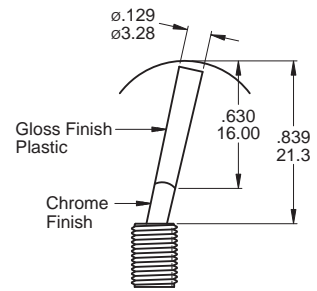

B1 / B2 bushing std with black(T92) and red(T93) color only(std.)

TL1B25 THD STD
B26 NON-THD

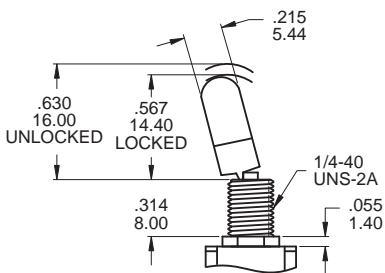

TL2B25 THD STD
B26 NON-THD

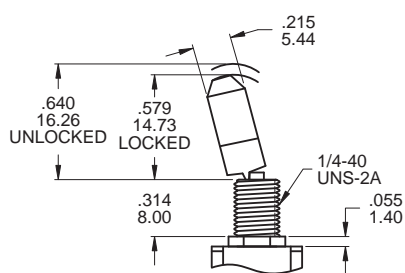

TL3B25 THD STD
B26 NON-THD

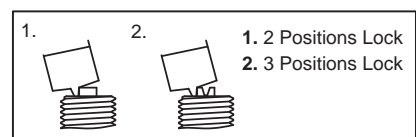
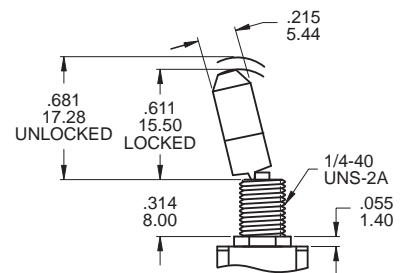

1M Series

Miniature Toggle Switches

BUSHING OPTIONS

1M
Toggle Switches

B1 THD STD
B2 NON-THD

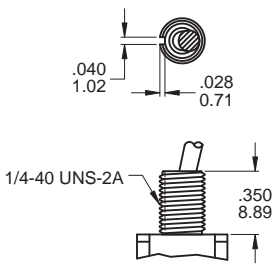

Subtract .016 (0.40) for M6, M7 and VS2-5 termination options.

B3 THD
B4 NON-THD

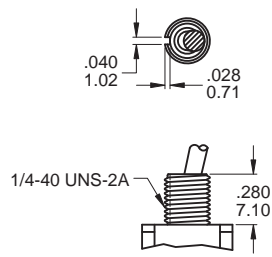

B4 is standard for M6, M7 and VS2-5 termination options.

B5 HIGH TORQUE

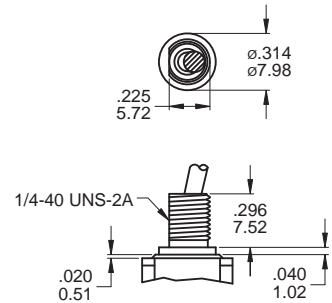

B6 HIGH TORQUE

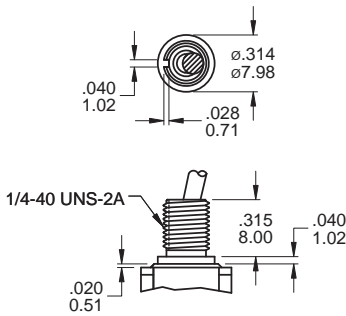

B7 THD STD

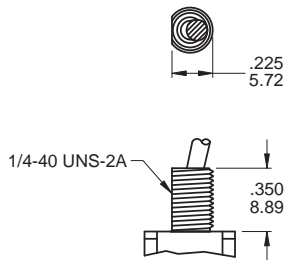

B8 METRIC THD

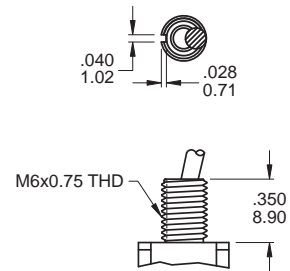

B9 SPLASH PROOF

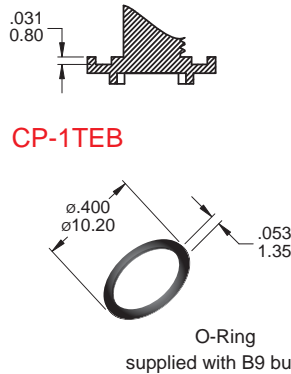
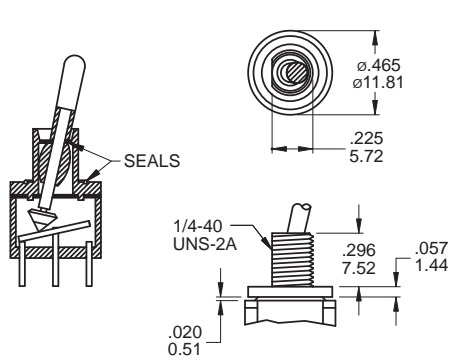

B11 THD STD
B12 NON-THD

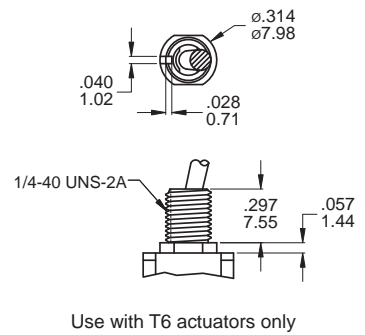

B15 THD STD
B16 NON-THD

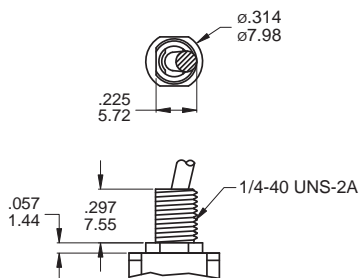

Use with T6 actuators only

B17

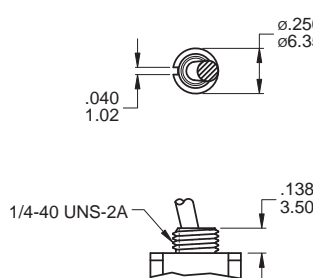

B13

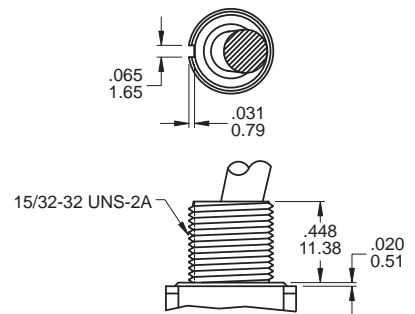

Use with T7, T8 actuators only
B13 Bear strength from top of actuator up to 10kg aside up to 15kg

B14 SPLASH PROOF

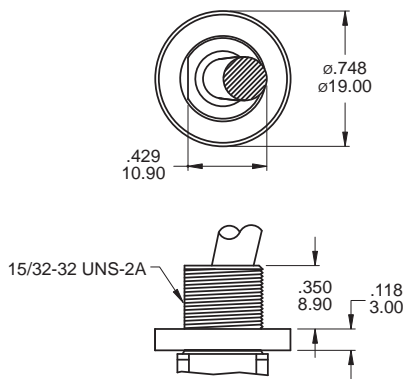

Use with T7, T8 actuators only

B18

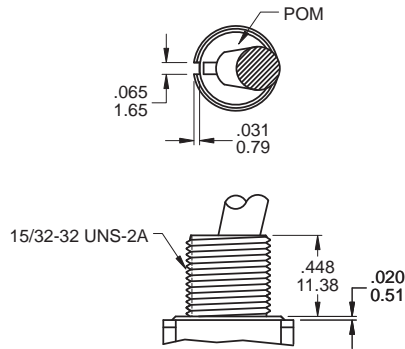

Use with T7, T8 and TA actuators only with Plastic (POM) Insert

B20

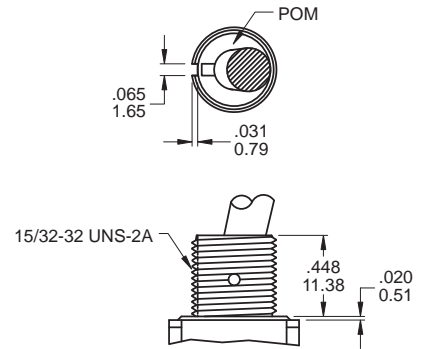

Use with T7, T8 and TA actuators only with Plastic (POM) Insert

B18, B20 Bear strength from top of actuator up to 20kg aside up to 15kg

OPTIONAL TOGGLE CAP

CP-1T1X

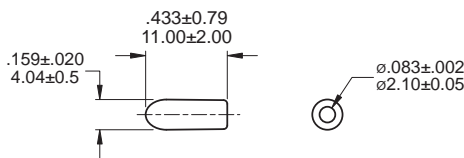

Use with T1 actuator

CAP Color :

ITEM NO	COLOR
1	White
2	Black (Std)
3	Red
5	Yellow
6	Green
7	Blue
9	Gray

* Besides standard color, other colors need to check stocks available.

PANEL MOUNTING

1/4 IN BUSHING

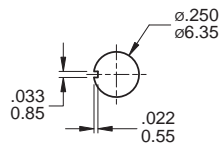

Without locking ring (Keyway)

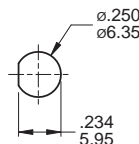

Without locking ring (Flat)

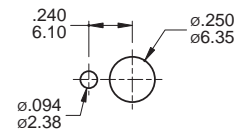

With standard locking ring.

METRIC BUSHING

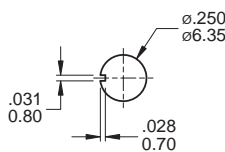

Without locking ring (Keyway)

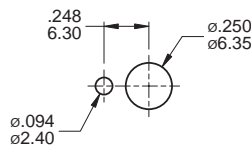

With standard locking ring.

15/32 IN BUSHING

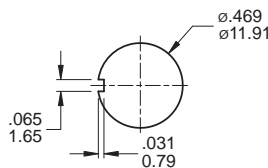

Without locking ring (Keyway)

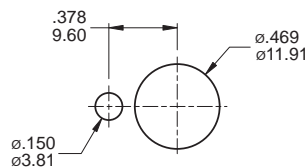

With standard locking ring.

SPLASH PROOF BUSHING

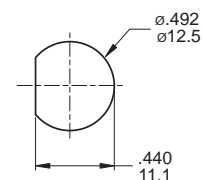

Without locking ring (Flat)

1M Series

Miniature Toggle Switches

TERMINATION OPTIONS

M1 Solder lug

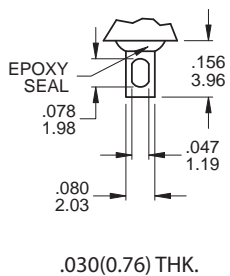

M2 PC Thru-hole

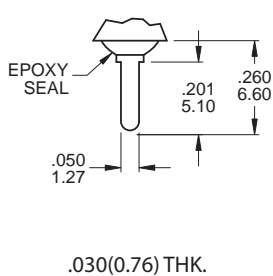

M3 Quick connect

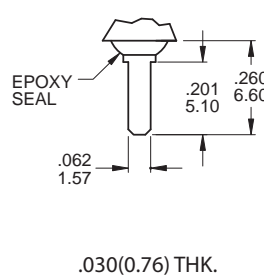

M5 Wire Wrap

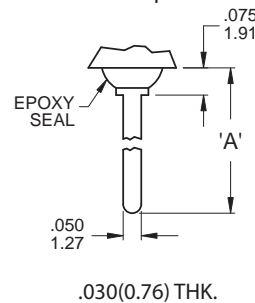

OTHER TERMINATION OPTIONS

M6 Right angle P.C. Mount

M7 Vertical right angle P.C. Mount

VS2 Vertical bracket P.C. Mount

VS3 Vertical bracket P.C. Mount

VS5 Vertical bracket P.C. Mount

M6N Right angle P.C. Mount with snap-in bracket

V2N Vertical bracket P.C. Mount with snap-in bracket

OPTION CODE	DIM. 'A'
M51	.736 (18.70)
M52	.953 (24.20)
M53	.415 (10.55)
M54	1.062 (26.97)

M6

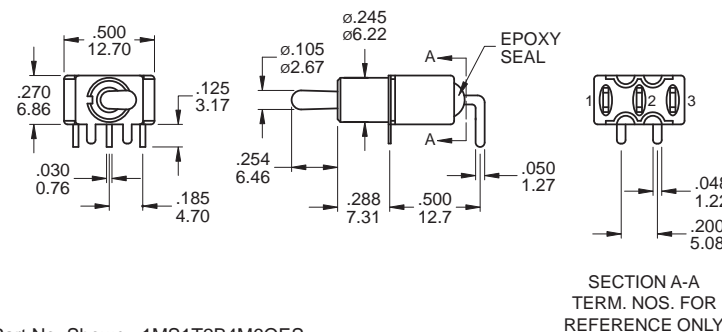

Part No. Shown : 1MS1T2B4M6QES

P.C. MOUNTING

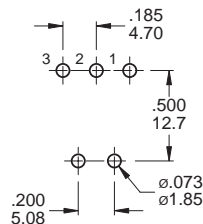

SPDT

SECTION A-A
TERM. NOS. FOR
REFERENCE ONLY

M6

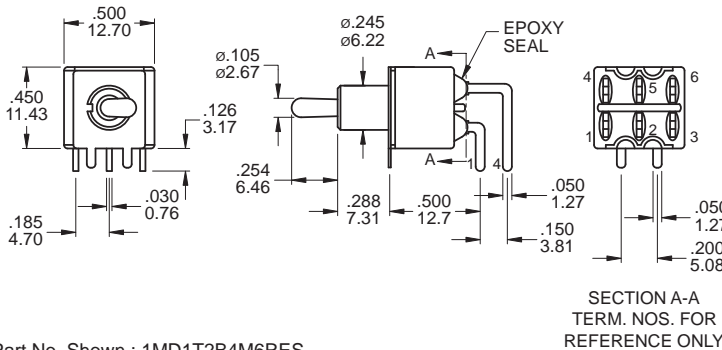

Part No. Shown : 1MD1T2B4M6RES

P.C. MOUNTING

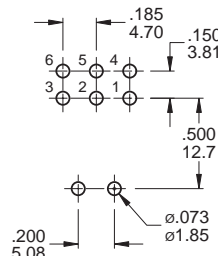

DPDT

SECTION A-A
TERM. NOS. FOR
REFERENCE ONLY

M7

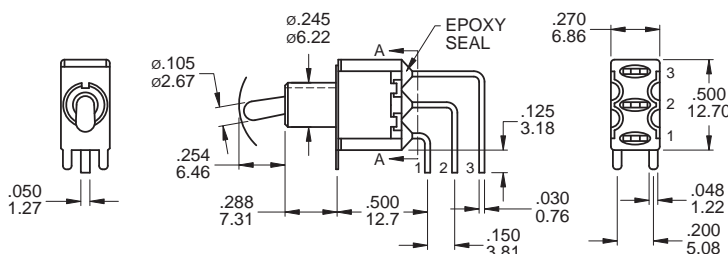

Part No. Shown : 1MS1T2B4M7QES

P.C. MOUNTING

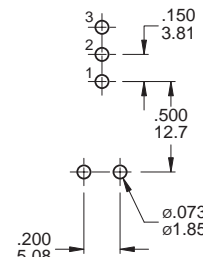

SPDT

SECTION A-A
TERM. NOS. FOR
REFERENCE ONLY

1M
Toggle Switches

M7

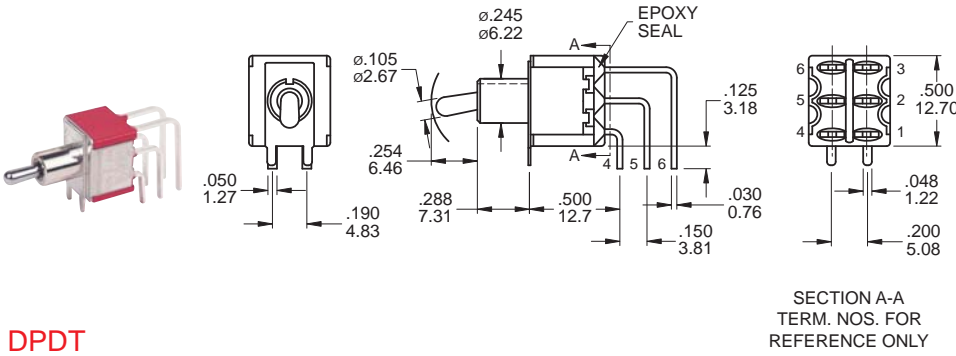

Part No. Shown : 1MD1T2B4M7QES

DPDT

M7

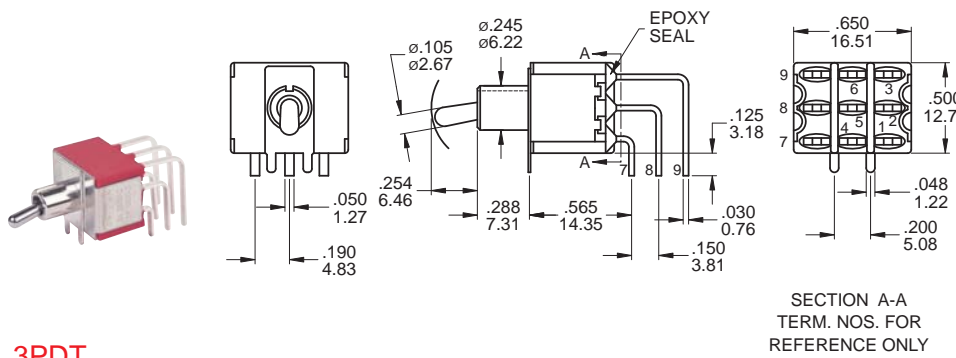

Part No. Shown : 1M31T2B4M7QES

3PDT

M7

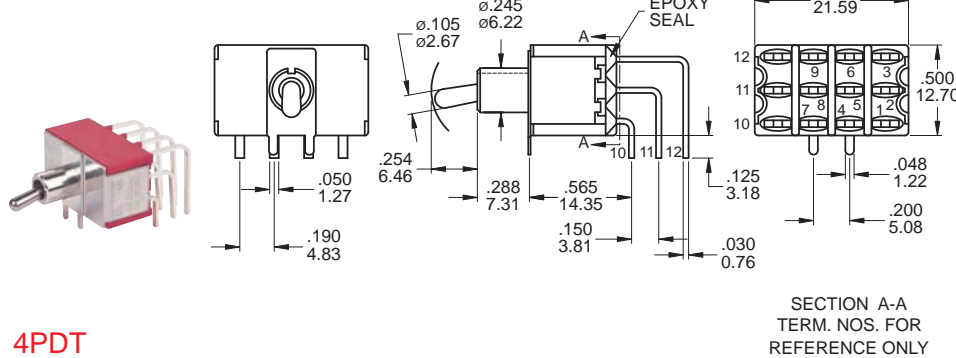

Part No. Shown : 1M41T2B4M7QES

4PDT

VS2 - VS3

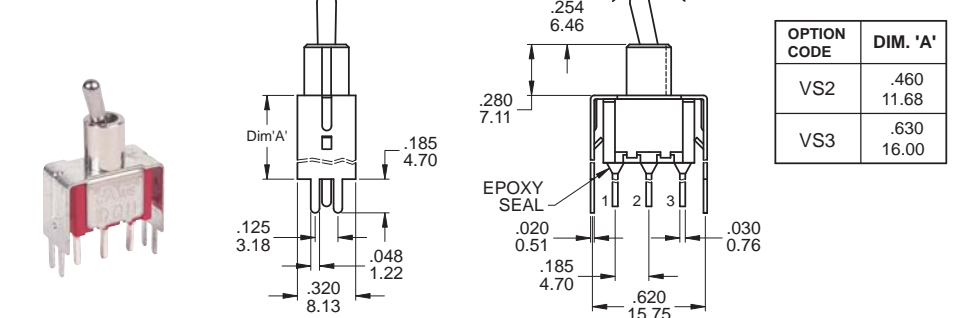

Part No. Shown : 1MS1T2B4VS2QES

SPDT

1M Series

Miniature Toggle Switches

1M
Toggle Switches

VS2 - VS3

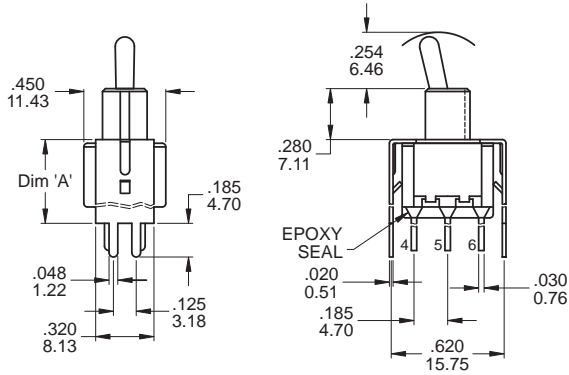
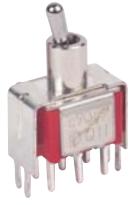

OPTION CODE	DIM. 'A'
VS2	.460 11.68
VS3	.630 16.00

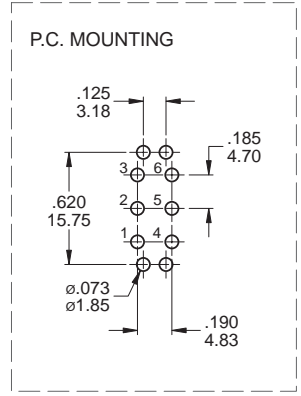

DPDT

Part No. Shown : 1MD1T2B4VS3QES

VS5

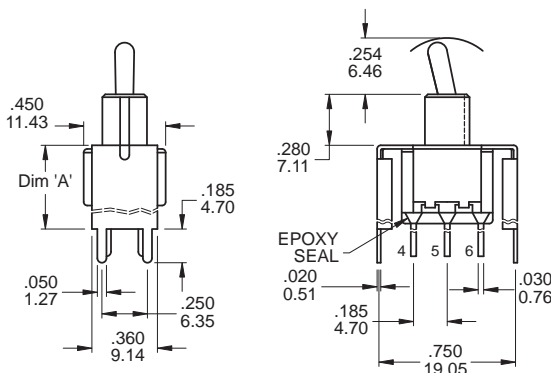

OPTION CODE	DIM. 'A'
VS4	.460 11.68
VS5	.630 16.00

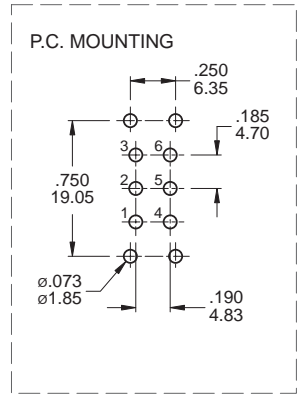

DPDT

Part No. Shown : 1MD1T2B4VS5QES

SNAP-IN TERMINATION OPTIONS

M6N

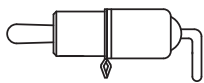
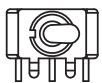

V2N

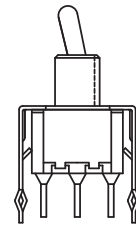

HARDWARE

1/4 NUT

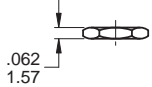
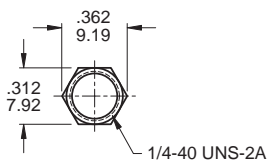

MNU-1M01A

DRESS NUT

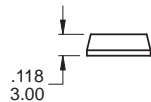
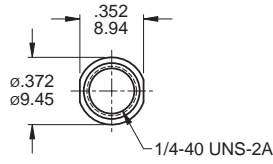

MNU-1M29

METRIC NUT

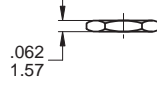
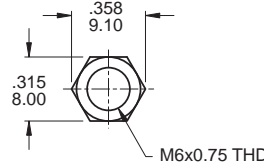

MNU-1M04

LOCKWASHER

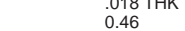
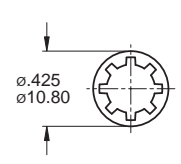

MNU-1M03

Supplied standard with B1, B3, B5, B6 and B9 options

Supplied standard with B8 metric bushing

Supplied standard with B1 / B3 bushing



LOCKING RING

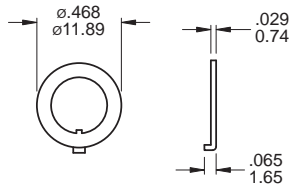

MNU-1M02

Locking ring supplied standard

LOCKING RING

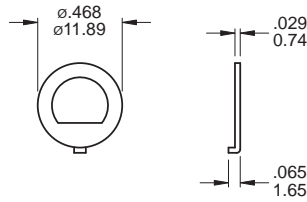

MNU-1M11

Locking ring supplied with B5 bushing

LOCKING RING

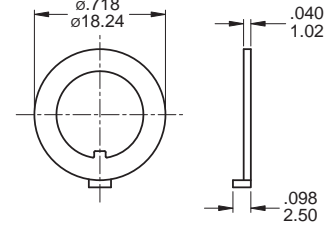

MNU-1M08

Locking ring supplied with B13, B18, B20 bushing

LOCKING RING

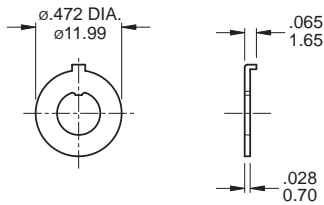

MNU-1M05

Locking ring supplied with B8 bushing

15/32 NUT

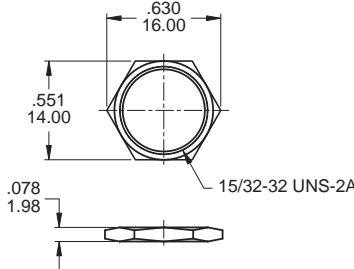

MNU1M07

Supplied standard with B13 bushing

LOCKWASHER

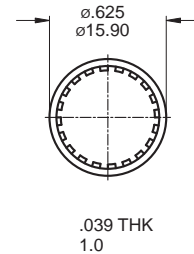

MNU-1M09

Supplied standard with B13 bushing

OPTIONAL RUBBER HOOD SEALING

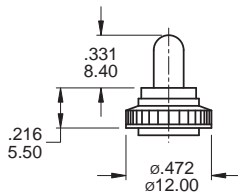

K1=Metric
E1=Inch (Std.)
for actuator T1, T2 and
B1, B3, B5, B6 Bushing only

DRESS NUT

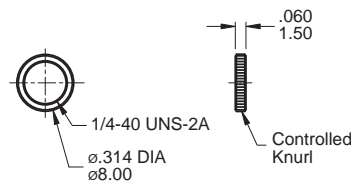

MNU-1M18

DRESS NUT

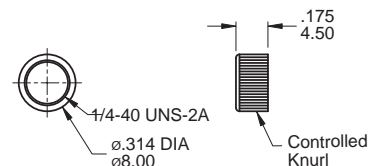

MNU-1M24

CONTACT MATERIAL OPTIONS

	CONTACT PLATING	TERMINAL PLATING	RATINGS
Q	Silver	Silver	5 Amps with resistant load @ 120VAC or 28VDC
C	Gold over Silver	Gold over silver	2 Amps with resistant load @ 250VAC
R	Gold	Gold	0.4 Volt - Amps (VA) max. @ 20V max. (AC or DC)

SOLDERING PROCESSES

MANUAL SOLDERING: Use soldering iron of 30 watts, controlled at 350°C approximately 5 seconds while applying solder.

WAVE SOLDERING: Recommended Soldering Temperature: 270 ± 5°C

Duration of Solder Immersion: Max 5 sec. (PCB is 1.6mm in thickness)