

# MN3007

## 1024-STAGE LOW NOISE BBD

### General description

The MN3007 is a 1024-stage long delay low noise BBD that provides a signal delay of up to 51.2msec.

The MN3007 is particularly suitable for use as reverberation effect of electronic musical instrument such as stereo equipment due to its long delay times.

### Features

- Variable delay time of audio signal: 5.12 ~ 51.2ms.
- Clock component cancellation capability.
- No insertion loss:  $L_i = 0\text{dB}$  typ.
- Wide dynamic range:  $S/N \approx 80\text{dB}$  typ.
- Wide frequency response:  $f_i \leq 12\text{KHz}$ .
- Low distortion:  $\text{THD} = 0.5\%$  typ. ( $V_i = 0.78\text{Vrms}$ ).
- Clock frequency range: 10 ~ 100KHz.
- P channel silicon gate process.
- 8-Lead Dual-In-Line Plastic Package.

### Applications

- Reverberation effect of echo microphone and stereo equipment.
- Chorus effect in electronic musical instrument.
- Variable or fixed delay of analog signals.
- Telephone time compression and delay line for voice communication systems, etc.

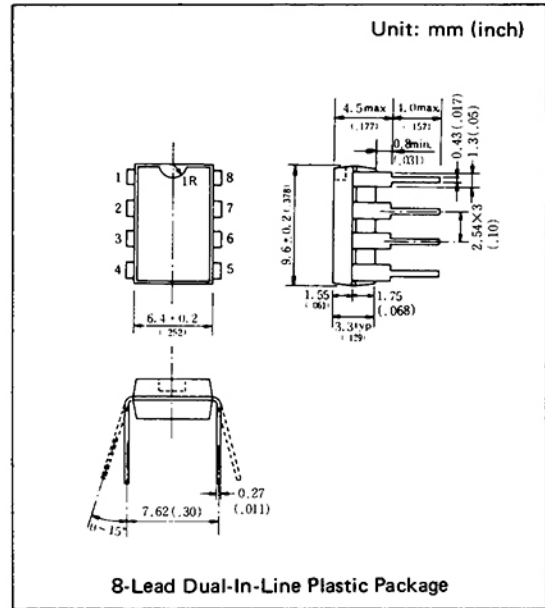

### Block Diagram

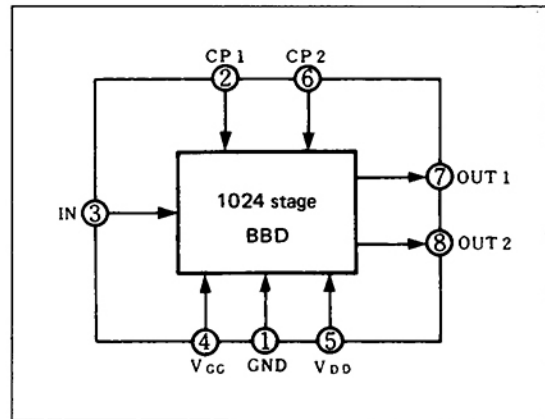

### Quick Reference Data

Item	Symbol	Value	Unit
Supply Voltage	$V_{DD}, V_{GG}$	-15, $V_{DD} + 1$	V
Signal Delay Time	$t_D$	5.12~51.2	ms
Total Harmonic Distortion	THD	0.5	%
Signal to Noise Ratio	S/N	80	dB

■ Absolute Maximum Ratings (Ta = 25°C)

Item	Symbol	Ratings	Unit
Terminal Voltage	V <sub>DD</sub> , V <sub>GG</sub> , V <sub>CP</sub> , V <sub>I</sub>	-18~+0.3	V
Output Voltage	V <sub>O</sub>	-18~+0.3	V
Operating Temperature	T <sub>opr</sub>	-20~+60	°C
Storage Temperature	T <sub>stg</sub>	-55~+125	°C

■ Operating Conditions (Ta = 25°C)

Item	Symbol	Condition	Min.	Typ.	Max.	Unit
Drain Supply Voltage	V <sub>DD</sub>		-14	-15	-16	V
Gate Supply Voltage	V <sub>GG</sub>			V <sub>DD</sub> + 1		V
Clock Voltage "H" Level	V <sub>CPH</sub>		0		-1	V
Clock Voltage "L" Level	V <sub>CPL</sub>			V <sub>DD</sub>		V
Clock Input Capacitance	C <sub>CP</sub>				700	pF
Clock Frequency	f <sub>CP</sub>		10		100	kHz
Clock Pulse Width *1	t <sub>cpw</sub>				0.5T *2	
Clock Rise Time *1	t <sub>cpr</sub>				500	ns
Clock Fall Time *1	t <sub>cpf</sub>				500	ns
Clock Cross Point *1	V <sub>X</sub>		0		-3	V
Input DC Bias	V <sub>Bias</sub>		-5		-10	V

■ Electrical Characteristics (Ta = 25°C, V<sub>DD</sub> = V<sub>CPL</sub> = -15V, V<sub>CPH</sub> = 0V, V<sub>GG</sub> = -14V, R<sub>L</sub> = 100kΩ)

Item	Symbol	Condition	Min.	Typ.	Max.	Unit
Signal Delay Time	t <sub>D</sub>		5.12		51.2	ms
Input Signal Frequency	f <sub>i</sub>	f <sub>CP</sub> = 40kHz, V <sub>i</sub> = 1.5Vrms, 3dB down (0dB at f <sub>i</sub> = 1kHz)	12			kHz
Input Signal Swing	V <sub>i</sub>	f <sub>CP</sub> = 40kHz, f <sub>i</sub> = 1 kHz, THD = 2.5%	1.5			Vrms
Insertion Loss	L <sub>i</sub>	f <sub>CP</sub> = 40kHz, f <sub>i</sub> = 1 kHz, V <sub>i</sub> = 1.5Vrms	-4	0	4	dB
Total Harmonic Distortion	THD	f <sub>CP</sub> = 40kHz, f <sub>i</sub> = 1 kHz, V <sub>i</sub> = 0.78Vrms		0.5	2.5	%
Noise Voltage	V <sub>NO</sub>	f <sub>CP</sub> = 100kHz Weighted by "A" curve			0.3	mVrms
Signal to Noise Ratio	S/N			80		dB

\*1 Clock Pulse Waveforms

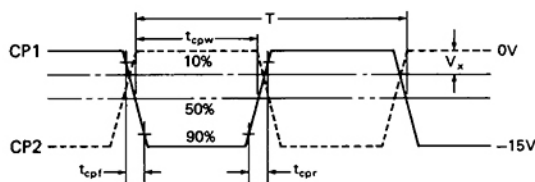

\*2 T = 1/f<sub>CP</sub> (Clock period)

■ Terminal Assignments

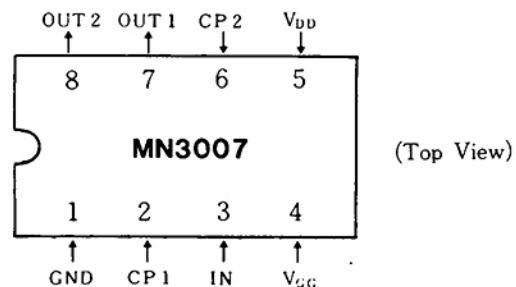

■ Circuit Diagram

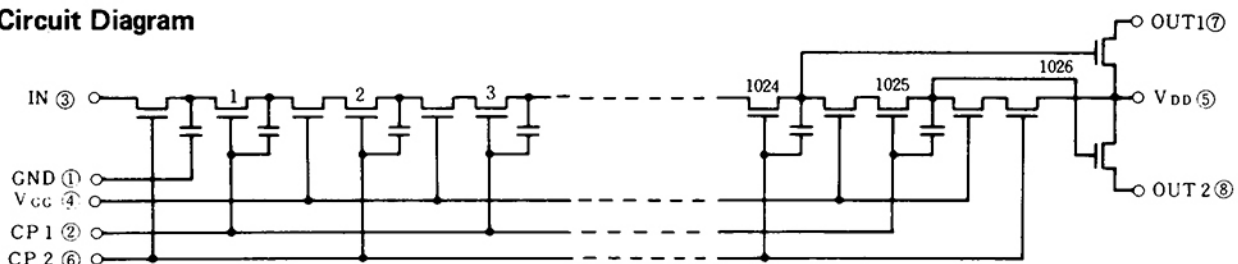

■ Typical Electrical Characteristic Curves

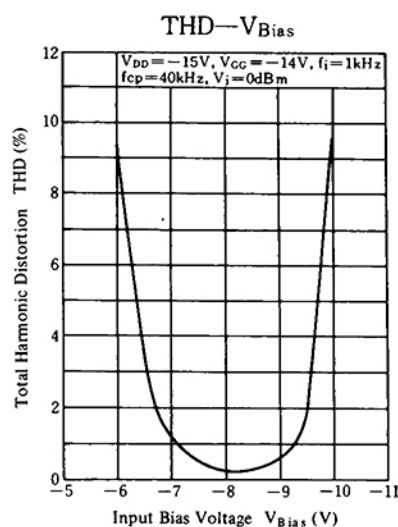
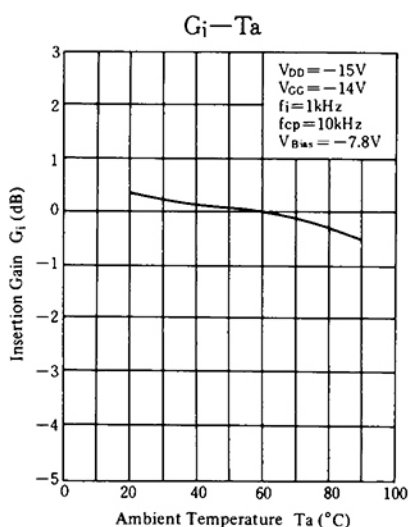
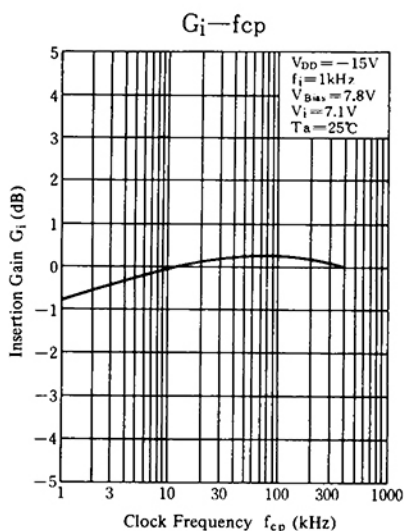
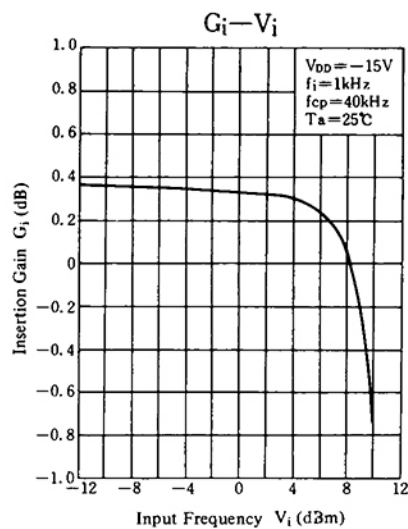
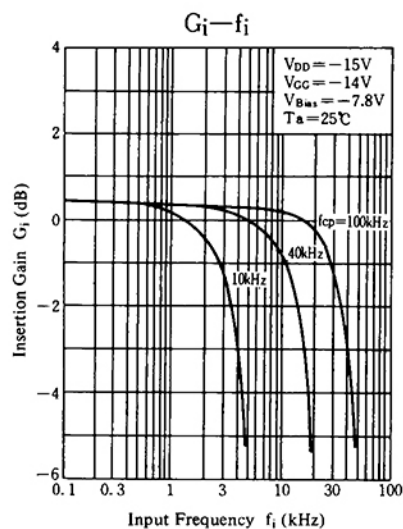
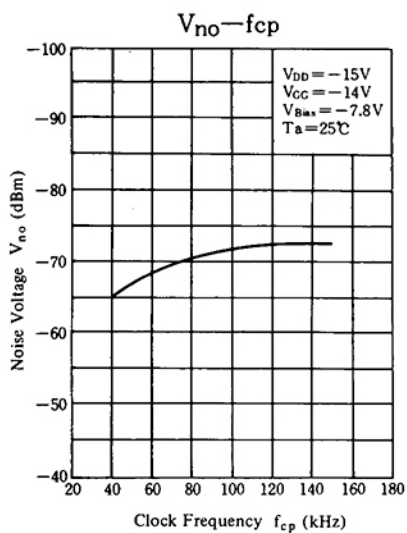
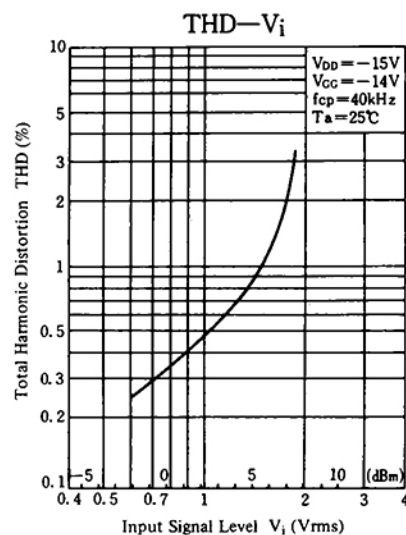
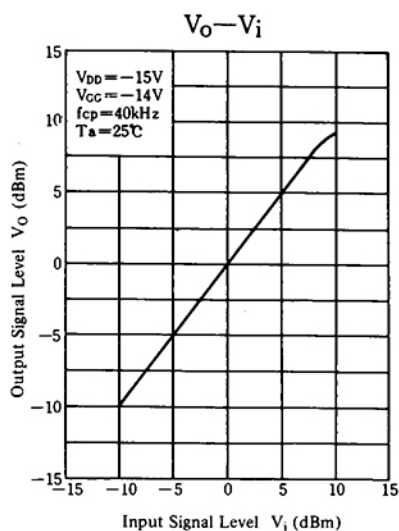
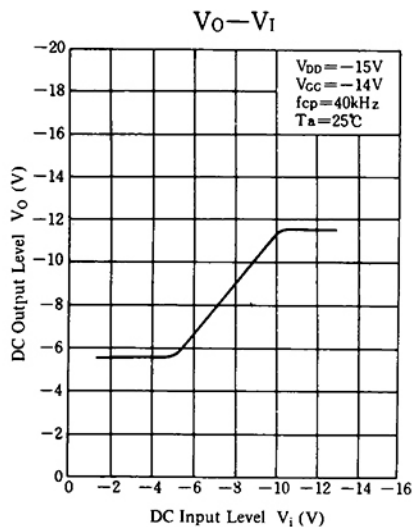

Supply Voltage Characteristics

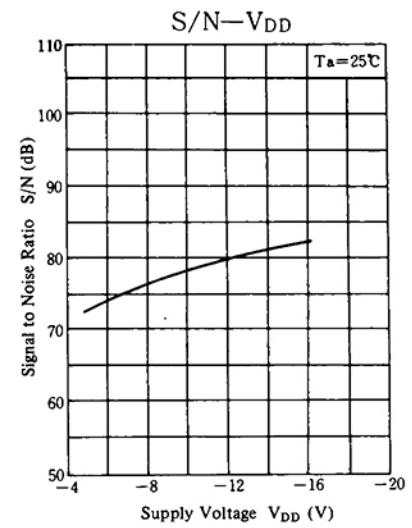
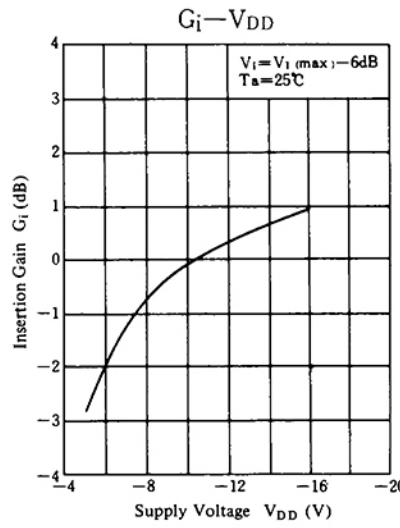
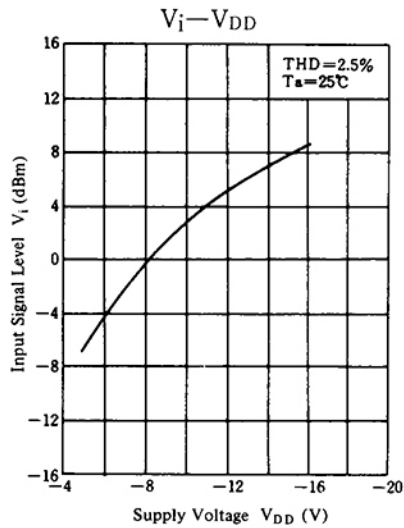
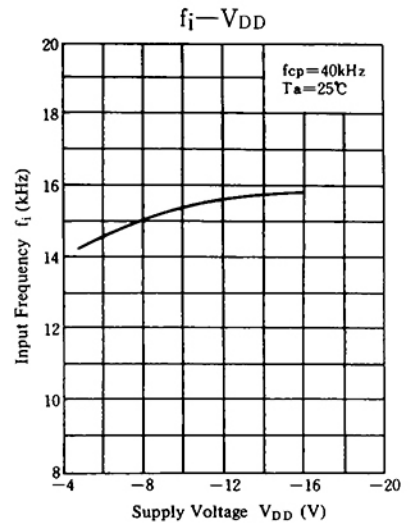
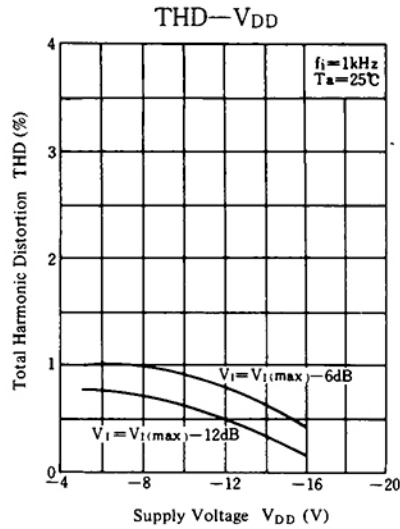
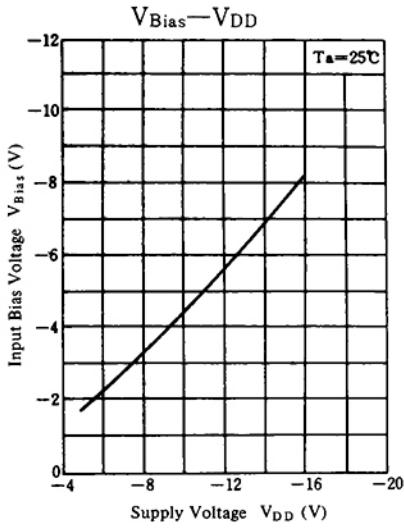

Application Circuit

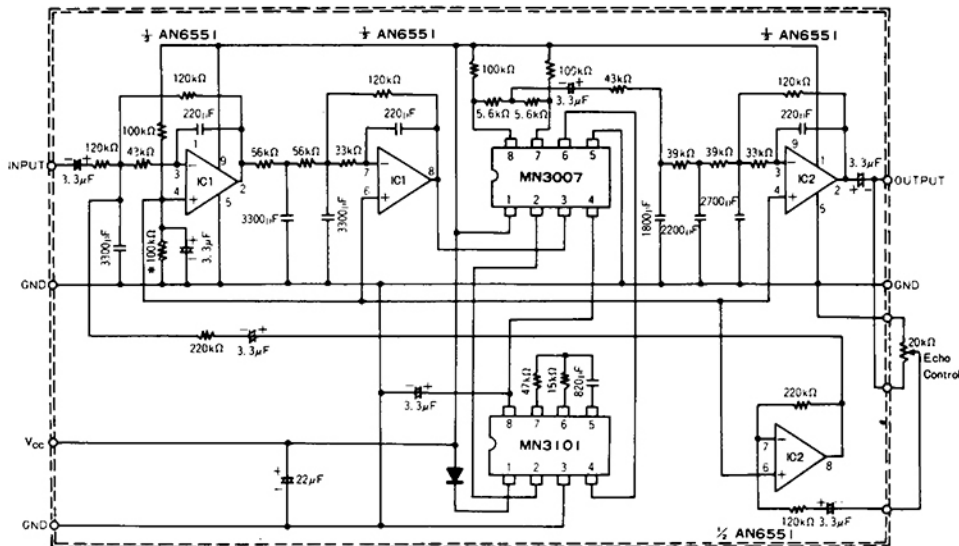

\* Adjust to minimize distortion (VR 100kΩ typ.)

Echo Effect Generation Circuit (Signal Delay Over 10msec.)