

LOW-NOISE DUAL PRE-AMPLIFIER

■ GENERAL DESCRIPTION

The NJM2043 is a bipolar operational amplifier which is designed as low noise version of the NJM4558 with high output current and fast slew rate (6V/μs) and wide unity gain bandwidth (14MHz) constructed using New JRC Planar epitaxial process.

■ FEATURES

- Operating Voltage (±4V~±22V)
- High Output Current (25mA.)
- Slew Rate (6V/μs typ.)
- Unity Gain Bandwidth (14MHz typ.)
- Package Outline DIP8,DMP8,SIP8
- Bipolar Technology

■ PACKAGE OUTLINE

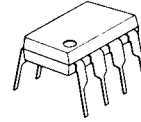

NJM2043D



NJM2043M

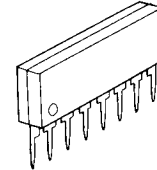

NJM2043L

■ PIN CONFIGURATION

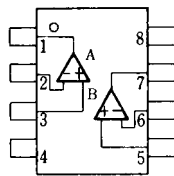

NJM2043D
NJM2043M

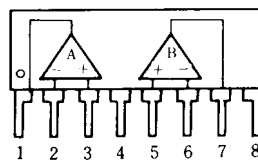

NJM2043L

PIN FUNCTION

- 1.A OUTPUT
- 2.A -INPUT
- 3.A +INPUT
- 4.V⁻
- 5.B +INPUT
- 6.B -INPUT
- 7.B OUTPUT
- 8.V⁺

■ EQUIVALENT CIRCUIT (1/2 Shown)

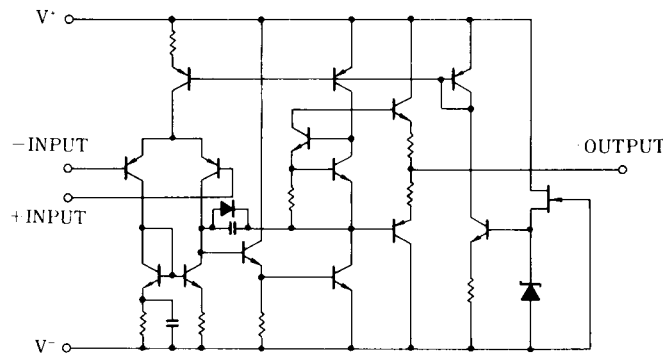

NJM2043

■ ABSOLUTE MAXIMUM RATINGS

(Ta=25°C)

PARAMETER	SYMBOL	RATINGS	UNIT
Supply Voltage	V^+ / V^-	± 22	V
Differential Input Voltage	V_{ID}	± 30	V
Input Voltage	V_{IC}	± 15 (note)	V
Power Dissipation	P_D	(DIP8) 500 (DMP8) 300 (SIP8) 800	mW
Operating Temperature Range	T_{opr}	-20~+75	°C
Storage Temperature Range	T_{stg}	-40~+125	°C

(note) For supply voltage less than ±15V, the absolute maximum input voltage is equal to the supply voltage.

■ ELECTRICAL CHARACTERISTICS

(Ta=25°C, $V^+ / V^- = \pm 15V$)

PARAMETER	SYMBOL	TEST CONDITION	MIN.	TYP.	MAX.	UNIT
Input Offset Voltage	V_{IO}	$R_S \leq 10k\Omega$	-	0.3	3	mV
Input Offset Current	I_{IO}		-	10	200	nA
Input Bias Current	I_B		-	400	1000	nA
Input Resistance	R_{IN}		30	100	-	kΩ
Large signal Voltage Gain	A_V	$R_L \geq 2k\Omega, V_O = \pm 10V$	86	100	-	dB
Maximum Output Voltage Swing 1	V_{OM1}	$R_L \geq 10k\Omega$	± 12	± 14	-	V
Maximum Output Voltage Swing 2	V_{OM2}	$I_O = 25mA$	± 10	± 11.5	-	V
Input Common Mode Voltage Range	V_{ICM}		± 12	± 14	-	V
Common Mode Rejection Ratio	CMR	$R_S \leq 10k\Omega$	70	100	-	dB
Supply Voltage Rejection Ratio	SVR	$R_S \leq 10k\Omega$	76	100	-	dB
Operating Current	I_{CC}		-	6	8	mA
Slew Rate	SR		-	6	-	V/μs
Gain Bandwidth Product	GB		-	14	-	MHz
Equivalent Input Noise Voltage	V_{NI}	FLAT+JISA $R_S = 300\Omega$	-	0.4	0.51	μVrms

(note1) Closed loop gain should be more than 20dB at use.

(note2) New JRC's general selected products D rank are also prepared for the noise standard ($R_S = 2.2k\Omega, R_{IAA}, V_{NI} = 1.4\mu V$ Max.)

■ TYPICAL CHARACTERISTICS

Open Loop Voltage Gain vs. Frequency

($V^+/V^- = \pm 15V$, $R_L = 2k\Omega$, $T_a = 25^\circ C$)

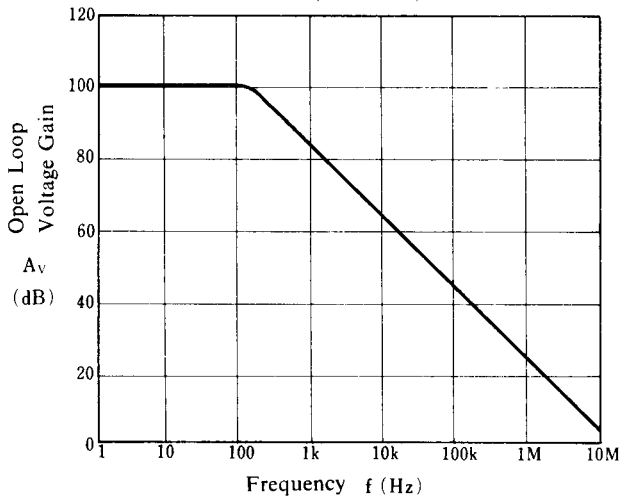

Equivalent Input Noise Voltage

($V^+/V^- = \pm 15V$, $T_a = 25^\circ C$)

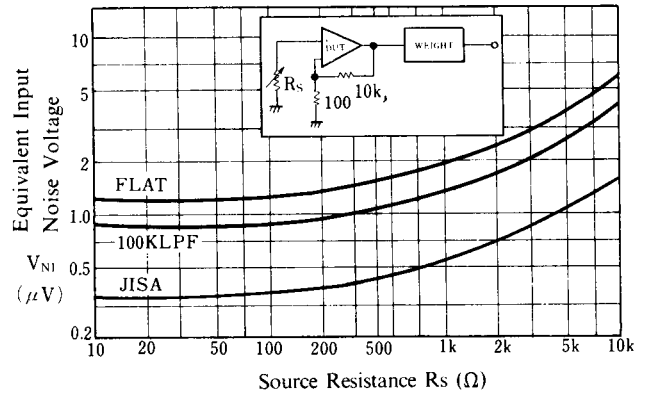

Maximum Output Voltage Swing vs. Load Resistance

($V^+/V^- = \pm 15V$, $T_a = 25^\circ C$)

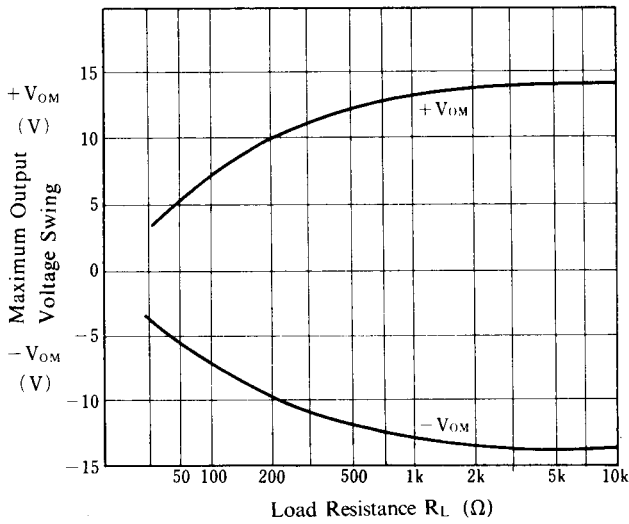

Maximum Output Voltage Swing vs. Output Current

($V^+/V^- = 15V$, $T_a = 25^\circ C$)

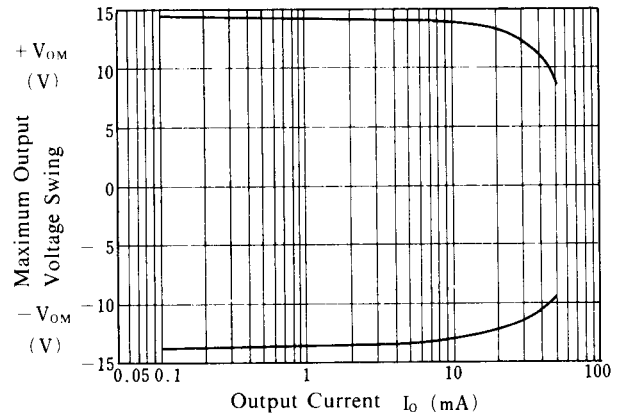

Operating Current vs. Temperature

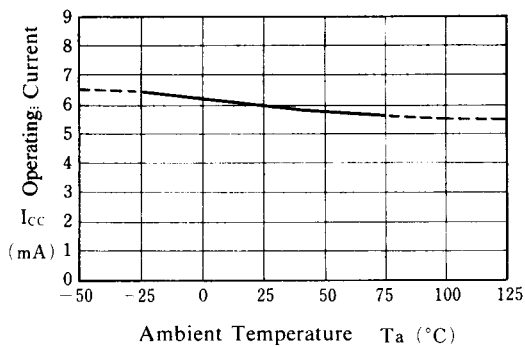

Maximum Output Voltage Swing vs. Temperature

($V^+/V^- = 15V$, $R_L = 10k\Omega$)

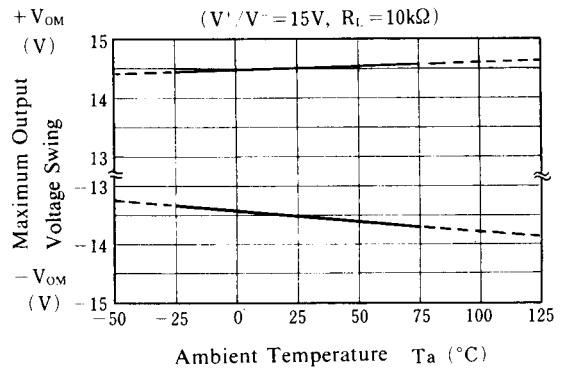

■ TYPICAL CHARACTERISTICS

Input Offset Voltage vs. Temperature

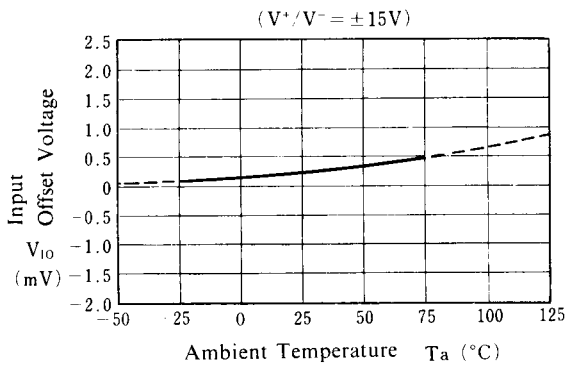

Input Bias Current vs. Temperature

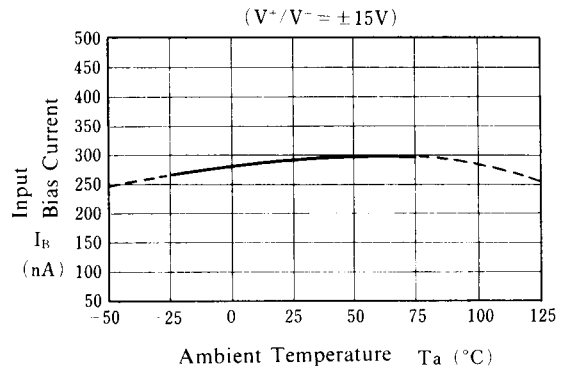

Maximum Output Voltage Swing vs. Operating Voltage

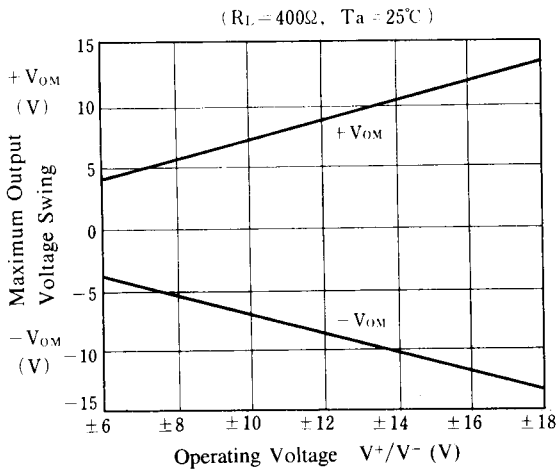

Maximum Output Voltage Swing vs. Supply Voltage

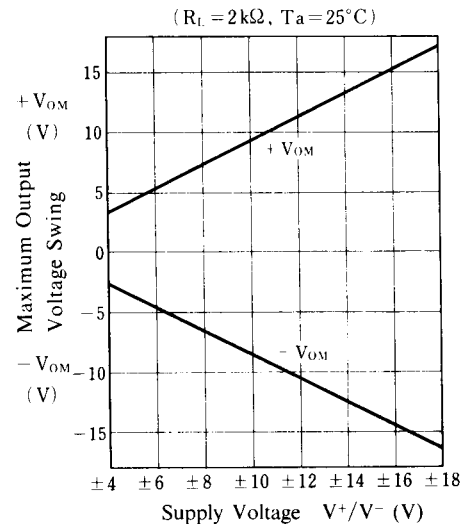

Operating Current vs. Operating Voltage

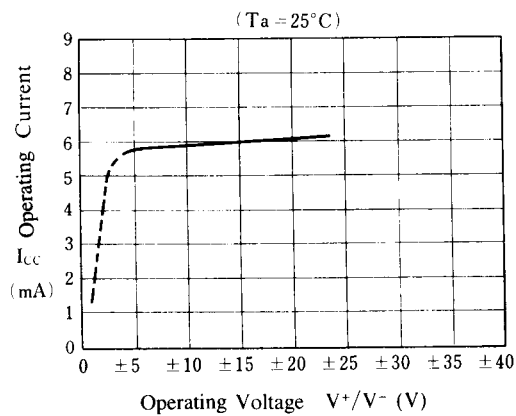

Maximum Output Voltage Swing vs. Frequency

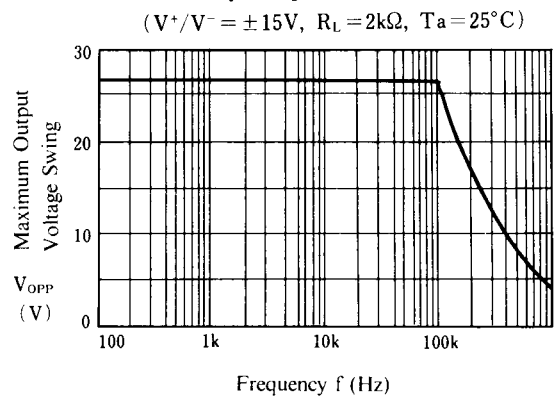

[CAUTION]

The specifications on this databook are only given for information, without any guarantee as regards either mistakes or omissions. The application circuits in this databook are described only to show representative usages of the product and not intended for the guarantee or permission of any right including the industrial rights.